



Product Specifications

Full Color Asynchronous Control Card

HD-C36

V0.1 20210603

1. System Overview

HD-C36 Full Color Asynchronous Controller System is a LED control system that supports mobile APP wireless management, Web-based cloud remote control, relay function for remote switch on/off power supply and 60Hz frame HD video image output and it support 524,288 pixels control capacity.

Supported computer software *HDPlayer*, mobile phone control software *LedArt* and *HD Cloud Platform*.

HD-C36 integrated sending card and receiving card function, can single cassette with small screen, can also add HD-R series receiving card to control bigger screen.

Controlling System Configuration

Product	Type	Functions
Async controller Card	HD-C36	Asynchronous core control panel, with storage capabilities, can be connected to the screen modules, with 2 lines 50PIN HUB port.
Receiving Card	R Series	Connected with screen, Showing program in Screen.
Control Software	HDPlayer	Screen parameters setting, edit & send program etc.

2. Control Mode

1. Internet unified management: The player box can be connected to the Internet through 4G (optional), network cable connection, or Wi-Fi Bridge.

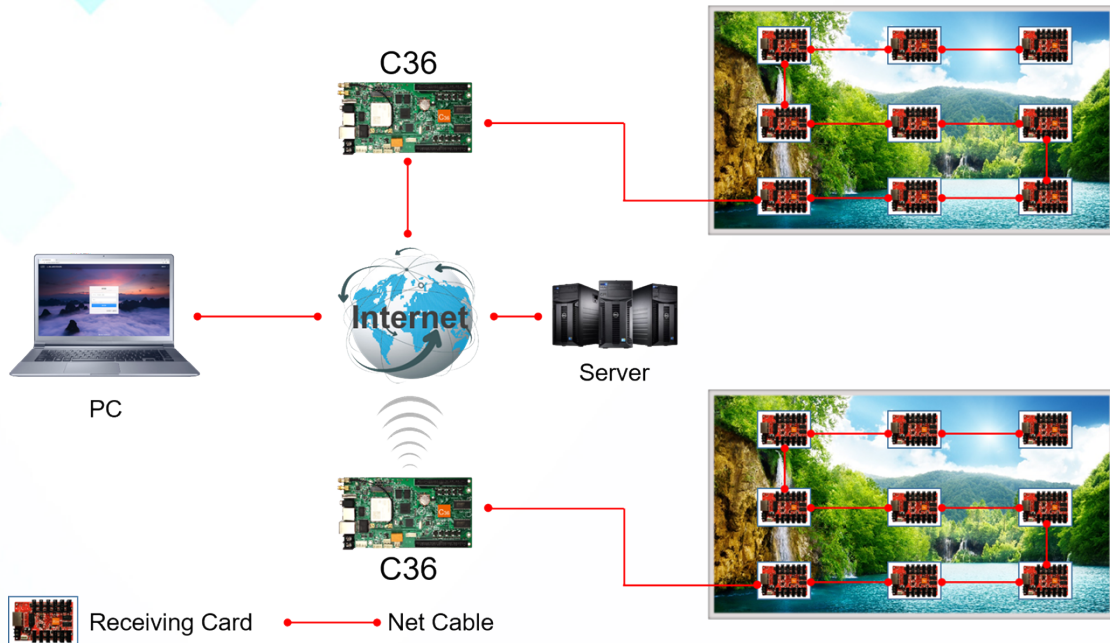

2. Asynchronous one-to-one control: Update programs by network cable connections, Wi-Fi connections or USB flash drives. LAN (cluster) control can access to the LAN network through network cable connection or Wi-Fi Bridge.

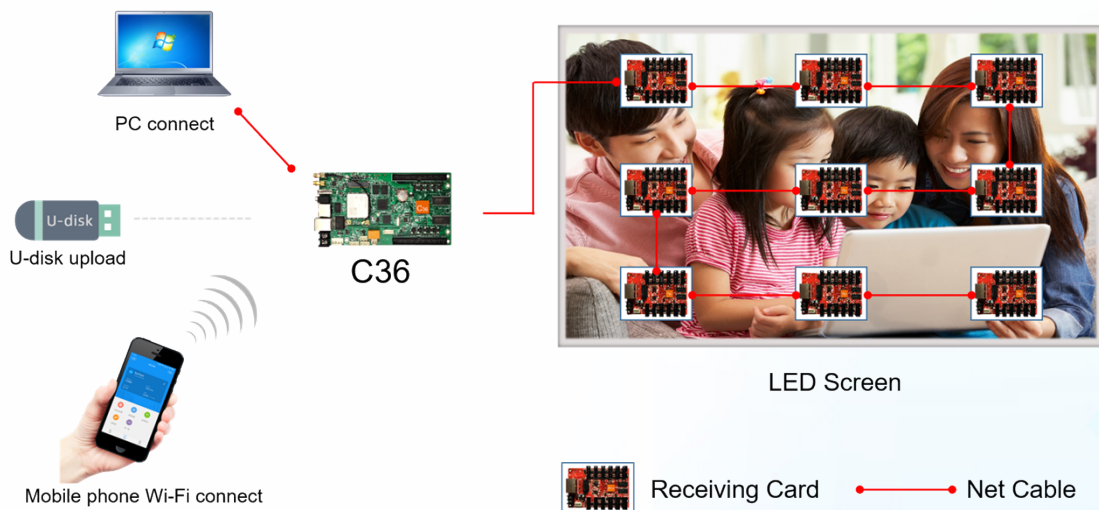

3. Product Features

- Control Range: **524,288** pixels (1024*512).
- 4GB memory, support expanding memory by U-disk.
- Support HD video hardware decoding, 60Hz frame rate output.
- Support widest 8192 pixels, Highest 1024 pixels.
- No need set IP address, it could be identified by controller ID automatically.
- Unified management of more LED display through Internet or LAN.
- Equipped with Wi-Fi function, Mobile APP management directly.
- Equipped with 3.5mm standard audio interface output.
- Meanwhile support to add 4G networking module connect to Internet (Optional).
- Equipped with 2 lines 50PIN HUB port, can be used for one receiving card.
- Equipped with 1 group of relay module, support switch on/off power supply directly remotely.

4. System Function List

Module type	Compatible with indoor and outdoor full color and single color module Support conventional chip and mainstream PWM chip
Scan Mode	Static to 1/64 scan mode
Control Range	1024*512, widest 8192, highest 1024
Gray Scale	256-65536
Basic functions	Video, Pictures, Gif, Text, office, Clocks, Timing etc. Remote, Temperature, Humidity, Brightness etc.

Video format	Support 1080P HD video hardware decoding, direct transmission, without transcoding waiting. 60Hz frame frequency output; AVI, WMV, MP4, 3GP, ASF, MPG, FLV, F4V, MKV, MOV, DAT, VOB, TRP, TS, WEBM, etc.
Image Format	Support BMP, GIF, JPG, PNG, PBM, PGM, PPM, XPM, XBM etc.
Text	Text editing, Image, Word, Txt, Rtf, Html etc.
Document	DOC, DOCX, XLSX, XLS, PPT, PPTX etc. Office2007Document format.
Time	Classic Analog clock, digital clock and of clock with image background.
Audio output	Double track stereo audio output.
Memory	4GB Flash memory; Indefinite expanding of U-disk memory.
Communication	Ethernet LAN port, 4G network (optional), Wi-Fi, USB.
Working Temperature	-20°C-80°C
Port	INPUTS: 5V DC*1, 100 Mbps RJ45*1, USB 2.0*1, test button*1, sensor port*1, GPS port*1. OUT:1Gbps RJ45*1, AUDIO*1
Power	8W

5. Dimension Chart

HD- C36 dimension chart follow:

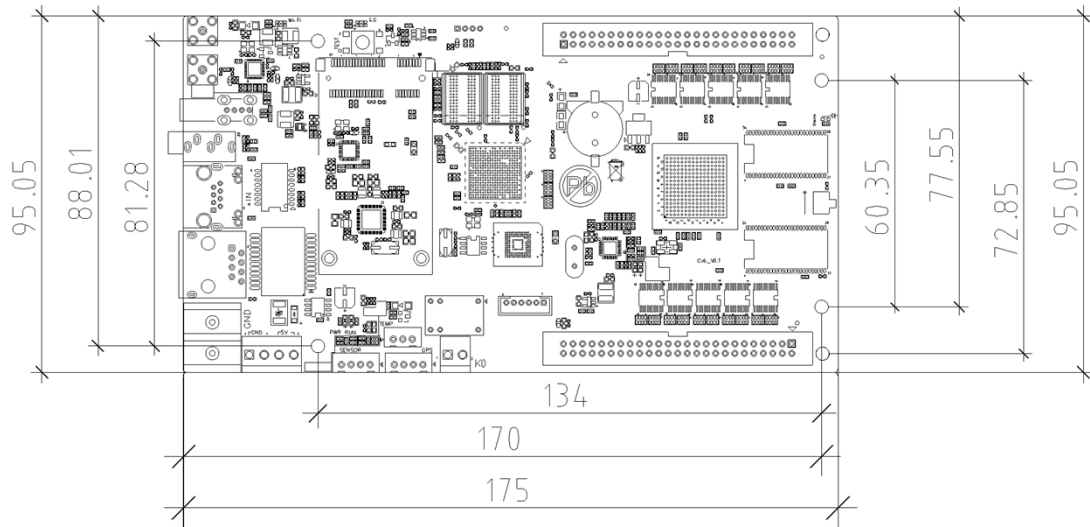

6. Interface Description

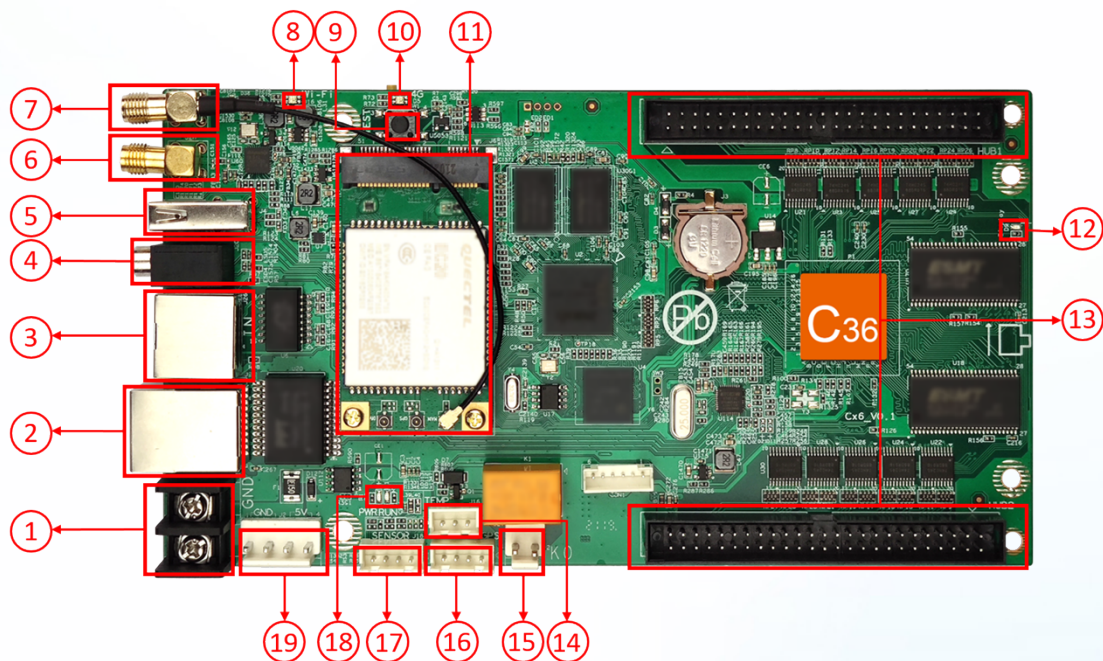

1. Power Supply port: connected 5V DC power supply.
2. Output network port: 1Gbps network port, connect to receiving card.
3. Input Network port: Connect to PC or router.

4. Audio output port: support standard two-track stereo output.
5. USB port: connected to USB device, e.g. U-disk, Mobile hard disk etc.
6. Wi-Fi antenna connection port: connect with external Wi-Fi antenna.
7. 4G network antenna connection port: connect with external 4G antenna.
8. Wi-Fi indicator light: display Wi-Fi work status.
9. Test button: LED screen burn-in test.
10. 4G indicator light: display 4G network status.
11. Mini PCIE port: connect with 4G networking module for cloud control (Optional).
12. Display indicator light: working status is Flicking.
13. HUB port: connect to HUB adapter board.
14. Temp sensor connection port: connect to temperature sensor and show the real-time value.
15. Relay control connection port: the power supply connection port of the relay
16. GPS port: connected GPS module.
17. Sensor port: connect S108 and S208 sensor kit.
18. Controller working state indicator light: PWR is Power lamp for status of power supply, when working normally, the lamp is always on, RUN is running lamp, when working normally, the lamp will be blinking.
19. Fool-proof power interface: 5V DC power interface, with fool-proof design, with the same function as the “1” 5V DC terminal.

7. Interface Definition

Onboard 2 lines 50PIN HUB port:

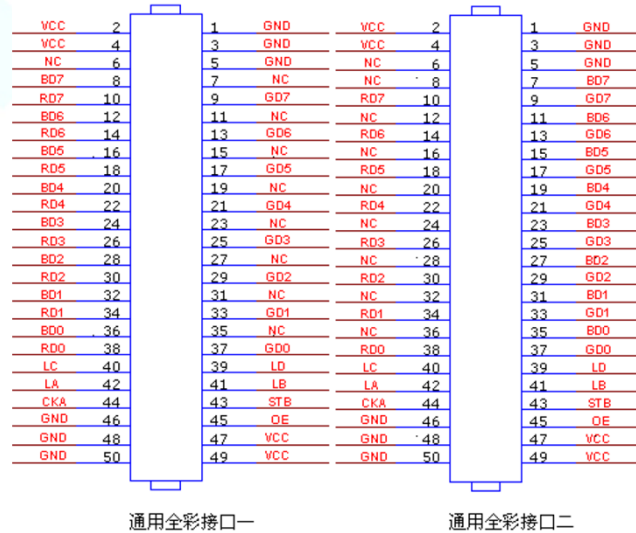

8. Basic Parameters

	Minimum	Typical	Maximum
Rated voltage(V)	4.2	5.0	5.5
Storage temperature(°C)	-40	25	105
Work environment temperature(°C)	-40	25	80
Work environment humidity (%)	0.0	30	95
Net weight (kg)			
Certificate	CE, FCC, RoHS		

Precaution

- 1) To ensure that the control card is stored during normal operation, make sure the battery on the control card is not loose,
- 2) In order to ensure the long-term stable operation of the system; please try to use the standard 5V power supply voltage.