



### ■ Features

- Constant Voltage + Constant Current mode output
- Protection Functions: OCP, SCP, OVP, OTP
- IP67 rating for indoor or outdoor installations
- Output adjustable via potentiometer
- Typical lifetime > 50000 hours
- 5 years warranty

### ■ Applications

- LED bay lighting
- LED stage lighting
- LED flood lighting
- LED strip lighting
- DMX control system

### ■ Description

ELG-300 series is a 300W LED driver featuring with constant current and Constant voltage mode design. ELG-300 operates from 100~305VAC and offers CV mode or CC mode applications. Thanks to the high efficiency up to 94%, with the fanless design, the ambient temperature can be operated for -40°C~+85°C case temperature under free air convection. The design of metal housing and IP67 ingress protection level allows this series to fit both indoor and outdoor applications. Moreover the innovative environment-adaptive capability allows this series to reliably light on the LEDs for all kinds of application environments in almost any spots that may install LED luminaires in the world ,as to provide the optimal design flexibility for LED lighting system.

### ■ Model Encoding

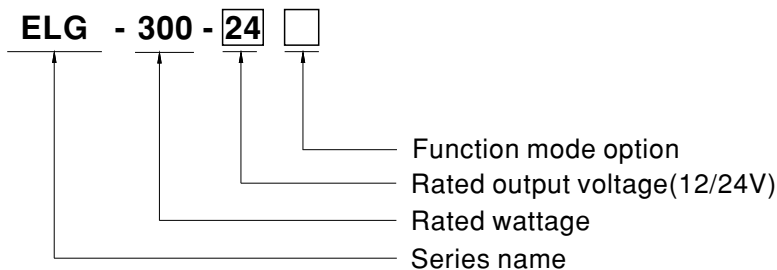

Type	IP Level	Function	Note
A	IP67	Io and Vo adjustable through built-in potentiometer	In Stock



**SPECIFICATION**

MODEL		ELG-300-12A	ELG-300-24A	
OUTPUT	DC VOLTAGE	12V	24V	
	CONSTANT CURRENT REGION <small>Note.2</small>	10~ 12V	14.4~ 24V	
	RATED CURRENT	200VAC ~ 305VAC	22A	12.5A
		100VAC ~ 180VAC	18.7A	10.63A
	RATED POWER	200VAC ~ 305VAC	264W	300W
		100VAC ~ 180VAC	224.4W	255W
	RIPPLE & NOISE (max.) <small>Note.3</small>	150mVp-p	240mVp-p	
	VOLTAGE ADJ. RANGE	11.2 ~12.8V	22.4 ~25.6V	
	CURRENT ADJ. RANGE	11 ~ 22A	6.25 ~ 12.5A	
	VOLTAGE TOLERANCE <small>Note.4</small>	±3.0%	±2.0%	
	LINE REGULATION	±0.5%	±0.5%	
	LOAD REGULATION	±2.0%	±1.0%	
SETUP, RISE TIME <small>Note.6</small>	500ms, 100ms/230VAC, 500ms, 100ms/115VAC			
HOLD UP TIME (Typ.)	10ms/ 230VAC 10ms/ 115VAC			
INPUT	VOLTAGE RANGE <small>Note.5</small>	100 ~ 305VAC 142 ~ 431VDC (Please refer to "STATIC CHARACTERISTIC" section)		
	FREQUENCY RANGE	47 ~ 63Hz		
	POWER FACTOR	PF ≥ 0.95/115VAC, PF ≥ 0.93/230VAC, PF ≥ 0.90/277VAC@full load		
	TOTAL HARMONIC DISTORTION	THD< 10%(@load≥50%/115VAC,230VAC; @load≥75%/277VAC)		
	EFFICIENCY (Typ.)	91%	94%	
	AC CURRENT	3A / 115VAC 1.6A / 230VAC 1.3A/277VAC		
	INRUSH CURRENT(Typ.)	COLD START 45A(twidth=1200μs measured at 50% Ipeak) at 230VAC; Per NEMA 410		
	MAX. No. of PSUs on 16A CIRCUIT BREAKER	2 units (circuit breaker of type B) / 4 units (circuit breaker of type C) at 230VAC		
LEAKAGE CURRENT	<0.75mA / 277VAC			
PROTECTION	OVER CURRENT	95 ~ 108% Constant current limiting, recovers automatically after fault condition is removed		
	SHORT CIRCUIT	Constant current limiting, recovers automatically after fault condition is removed		
	OVER VOLTAGE	13.5 ~ 17V	27 ~ 34V	
	OVER TEMPERATURE	Shut down output voltage, re-power on to recover		
ENVIRONMENT	WORKING TEMP.	Tcase=-40 ~ +85°C (Please refer to " OUTPUT LOAD vs TEMPERATURE" section)		
	MAX. CASE TEMP.	Tcase=+85°C		
	WORKING HUMIDITY	20 ~ 95% RH non-condensing		
	STORAGE TEMP., HUMIDITY	-40 ~ +80°C, 10 ~ 95% RH		
	TEMP. COEFFICIENT	±0.03%/°C (0 ~ 60°C)		
VIBRATION	10 ~ 500Hz, 5G 12min./1cycle, period for 72min. each along X, Y, Z axes			
SAFETY & EMC	SAFETY STANDARDS	UL8750(type"HL")(Except for 12V), CSA C22.2 No. 250.13-12; ENEC EN61347-1, EN61347-2-13 independent, EN62384; EAC TP TC 004; GB19510.1, GB19510.14; KC61347-1,KC61347-2-13; IS15885(Part2/Sec13),IP67 approved		
	WITHSTAND VOLTAGE	I/P-O/P:3.75KVAC I/P-FG:2.0KVAC O/P-FG:1.5KVAC		
	ISOLATION RESISTANCE	I/P-O/P, I/P-FG, O/P-FG:100M Ohms / 500VDC / 25°C / 70% RH		
	EMC EMISSION	Compliance to EN55015,EN61000-3-2 Class C (@load ≥ 50%) ; EN61000-3-3;KN15		
EMC IMMUNITY	Compliance to EN61000-4-2,3,4,5,6,8,11; EN61547, light industry level (surge immunity Line-Earth 6KV, Line-Line 4KV),KN61547			
OTHERS	MTBF	609K hrs min. Telcordia SR-332 (Bellcore) ; 191Khrs min. MIL-HDBK-217F (25°C)		
	DIMENSION	246*77*39.5mm (L*W*H)		
	PACKING	1.45 Kg; 9pcs /13.5Kg / 0.76CUFT		
NOTE	<ol style="list-style-type: none"> <li>All parameters NOT specially mentioned are measured at 230VAC input, rated current and 25°C of ambient temperature.</li> <li>Please refer to "DRIVING METHODS OF LED MODULE".</li> <li>Ripple &amp; noise are measured at 20MHz of bandwidth by using a 12" twisted pair-wire terminated with a 0.1uf &amp; 47uf parallel capacitor.</li> <li>Tolerance : includes set up tolerance, line regulation and load regulation.</li> <li>De-rating may be needed under low input voltages. Please refer to "STATIC CHARACTERISTIC" sections for details.</li> <li>Length of set up time is measured at first cold start. Turning ON/OFF the driver may lead to increase of the set up time.</li> <li>The driver is considered as a component that will be operated in combination with final equipment. Since EMC performance will be affected by the complete installation, the final equipment manufacturers must re-qualify EMC Directive on the complete installation again.</li> <li>This series meets the typical life expectancy &gt;50,000 hours of operation when Tcase, particularly (Ⓢ) point (or TMP, per DLC), is 70°C or less.</li> <li>Please refer to the warranty statement on MEAN WELL's website at <a href="http://www.meanwell.com">http://www.meanwell.com</a></li> <li>The ambient temperature derating of 3.5°C/1000m with fanless models and of 5°C/1000m with fan models for operating altitude higher than 2000m(6500ft).</li> <li>To fulfill requirements of the latest ErP regulation for lighting fixtures, this LED driver can only be used behind a switch without permanently connected to the mains.</li> <li>For any application note and IP water proof function installation caution, please refer our user manual before using. <a href="https://www.meanwell.com/Upload/PDF/LED_EN.pdf">https://www.meanwell.com/Upload/PDF/LED_EN.pdf</a></li> </ol>			

### ■ Block Diagram

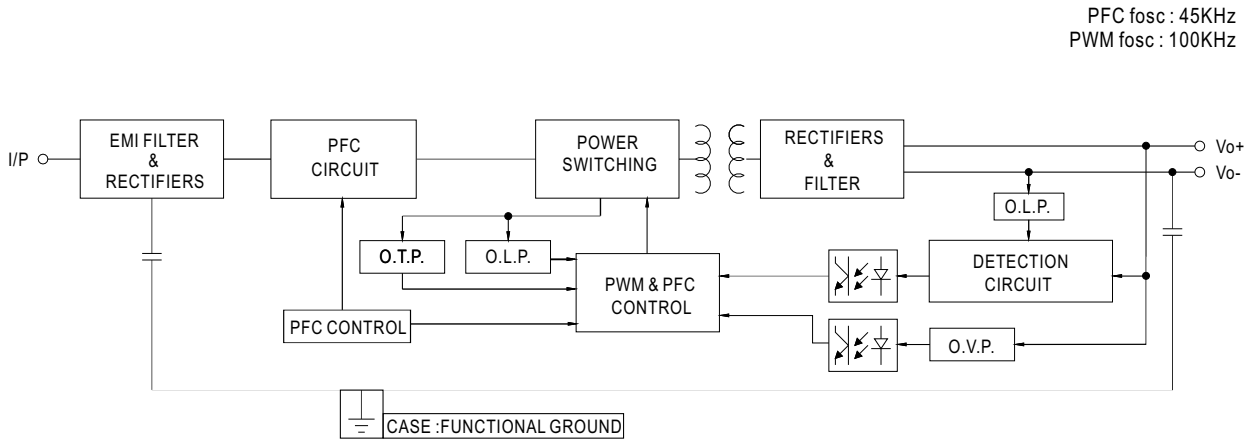

### ■ DRIVING METHODS OF LED MODULE

※ This series is able to work in either Constant Current mode (a direct drive way) or Constant Voltage mode (usually through additional DC/DC driver) to drive the LEDs.



Typical output current normalized by rated current (%)

In the constant current region, the highest voltage at the output of the driver depends on the configuration of the end systems.

Should there be any compatibility issues, please contact MEAN WELL.

### OUTPUT LOAD vs TEMPERATURE

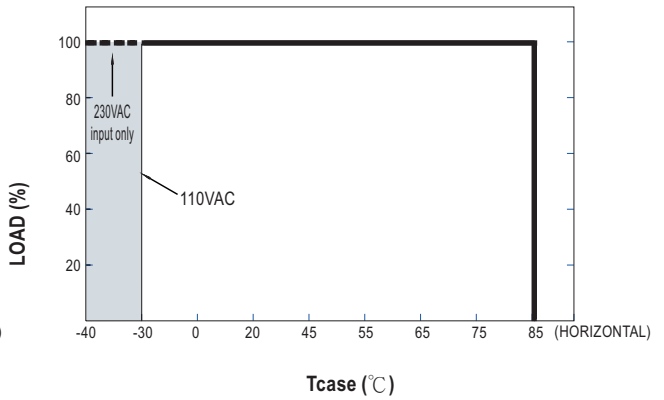
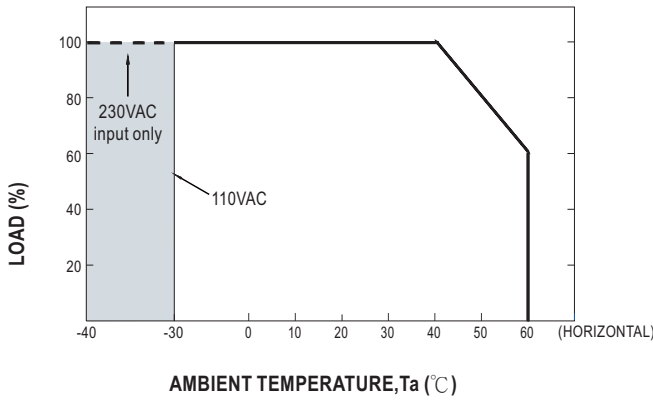

⊙ If ELG-300 operates in Constant Current mode with the rated current, the maximum workable Ta is 40°C.

### STATIC CHARACTERISTIC

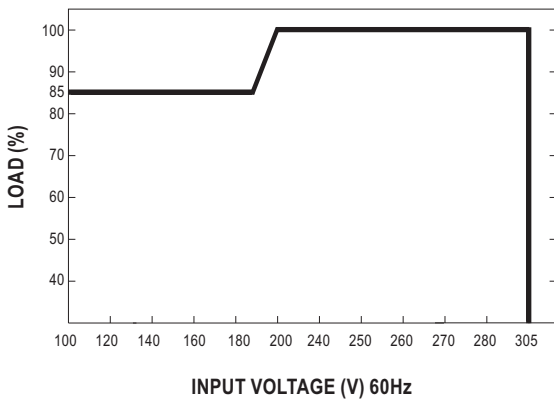

※ De-rating is needed under low input voltage.

### POWER FACTOR (PF) CHARACTERISTIC

※ Tcase at 75°C

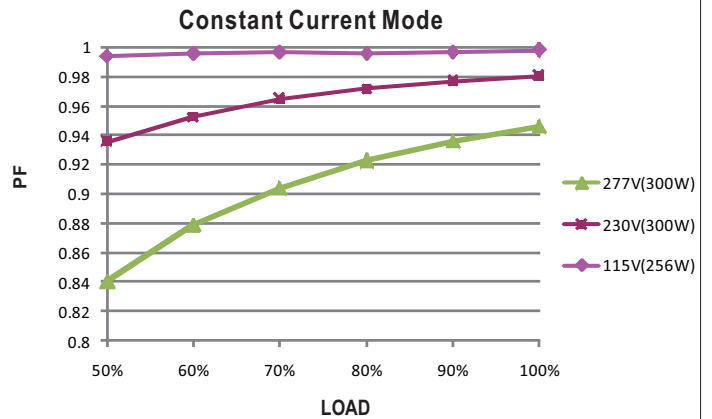

### TOTAL HARMONIC DISTORTION (THD)

※ ELG-300-24A Model, Tcase at 75°C

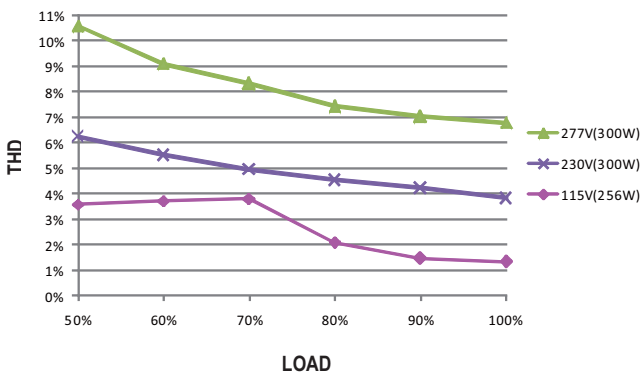

### EFFICIENCY vs LOAD

ELG-300 series possess superior working efficiency that up to 94% can be reached in field applications.

※ ELG-300-24A Model, Tcase at 75°C

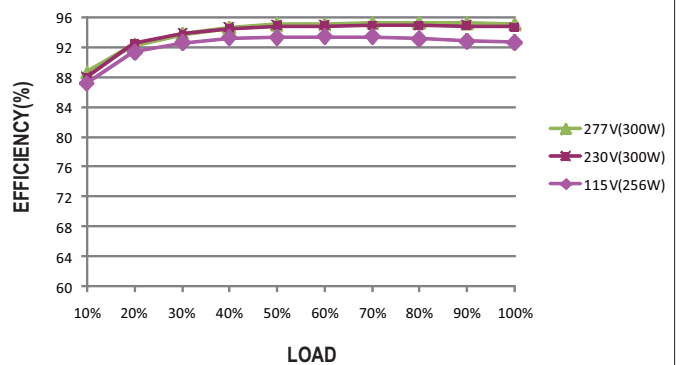

■ LIFE TIME

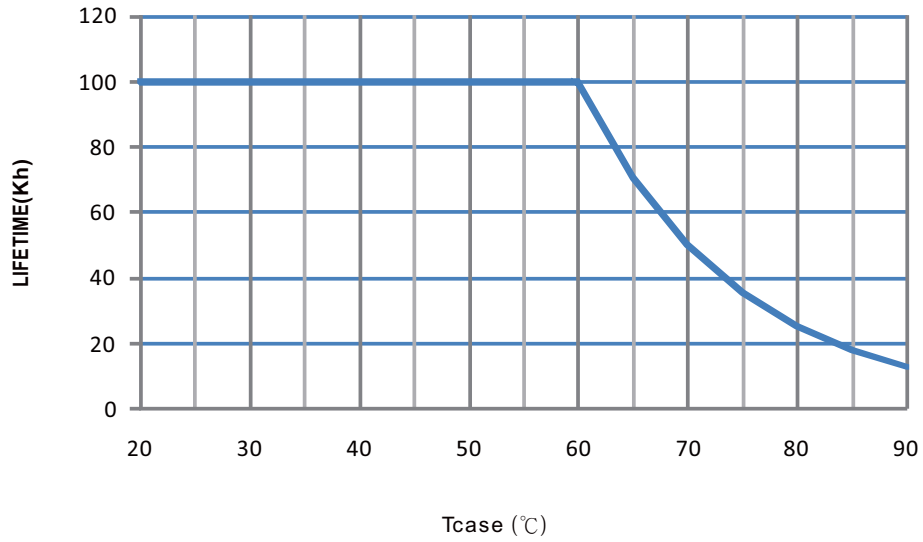

**MECHANICAL SPECIFICATION**

CASE NO.: 266A Unit:mm

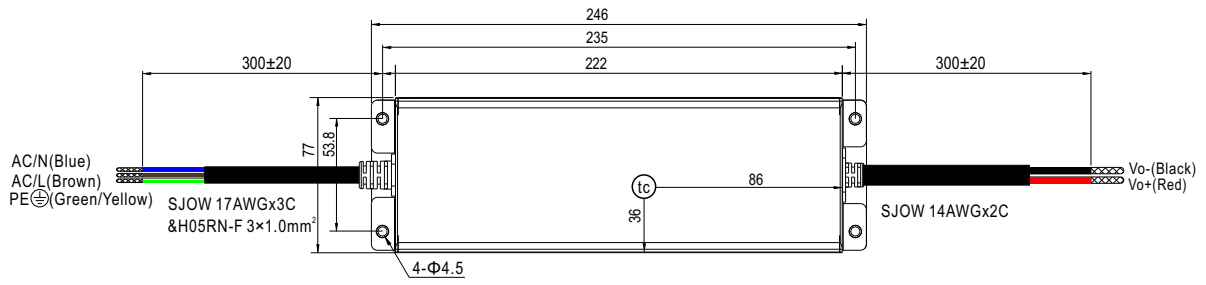

• (tc) : Max. Case Temperature

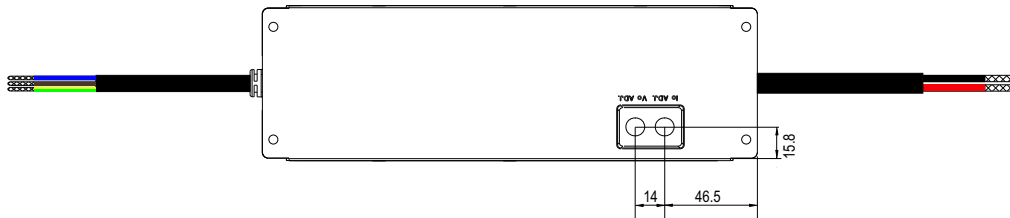

**INSTALLATION MANUAL**

Please refer to : <http://www.meanwell.com/manual.html>