



# LED Video Processor

User Manual V1.1

⚠ Before using this LED Video processor ,please read this manual carefully and preserved for reference in the future.

## **MAGNIMAGE**

LED-570E series

## Statements

Without the written permission, any unit or individual could not copy, reproduction or translate the book or part of it. Also could not transmit it in any form or any way ( electronic, mechanical, photocopying, record or other way) for any business and profitable purpose.

The product specifications and information mentioned in this manual is just for reference, will not give prior notice if there is any updated. Unless there is a special agreement, it is just used as guidelines. All the statements or information in this manual shall not constitute any form of guarantee.

# Directory

<b>Statements</b> .....	<b>1</b>
<b>Directory</b> .....	<b>1</b>
<b>Briefs</b> .....	<b>3</b>
Trademark Credit.....	3
About Software .....	3
Features.....	3
<b>Using Directions</b> .....	<b>5</b>
Including Accessories .....	5
Extended Port.....	6
Safety Instructions.....	6
<b>Function Introduction</b> .....	<b>7</b>
Brief.....	7
Front Panel Graphical Representation .....	8
RearPanel Graphical Representation.....	9
Technical Specification .....	11
<b>Using Menu</b> .....	<b>14</b>
How to use the keys .....	14
INPUTS area : .....	14
MENU area : .....	14
FUNCTION area : .....	15
Default state introduction .....	16
Main menu introduction .....	19
Main menu .....	20
Picture setting sub menu .....	21
Output setting sub menu .....	22
Video crop sub menu .....	24
Image Switching sub menu .....	25
Mosaic sub menu.....	26
Communication sub menu .....	27
Task manager sub menu.....	28
Misc sub menu .....	29
Dual image setting sub menu .....	30
Test pattern sub menu .....	32
Language sub menu.....	33
<b>Input signal hot backup</b> .....	<b>34</b>
Summarize.....	34
How to use hot backup?.....	34

<b>Setting EDID .....</b>	<b>36</b>
EDID Summarize .....	36
How to set EDID .....	36
Setting DVI EDID : .....	36
Setting DP EDID : .....	36
<b>iDP&amp; DP Loop .....</b>	<b>37</b>
iDP & DP Loop Summarize .....	37
How to use iDP & DP Loop? .....	37
<b>Preview Mode .....</b>	<b>39</b>
Preview Summarize .....	39
How to use preview? .....	39
<b>Multi machine connection .....</b>	<b>41</b>
Connect type .....	41
Multi machine load template .....	42
<b>Single machine support mosaic within 4K .....</b>	<b>44</b>
DVI output port introduction .....	44
Single machine suport zoom mosaic within 4K .....	44
Single machine support pixel-to-pixel mosaic within 4K .....	45
<b>Solutions .....</b>	<b>47</b>
Solution 1 : Support pixel-to-pixel mosaic within 4K*2K .....	47
Solution 2 : 1920×2160( pixel-to-pixel mosaic) .....	49
<b>FAQ .....</b>	<b>51</b>
<b>Warranty .....</b>	<b>53</b>
The whole unit warranty .....	53
The warrnty provisions .....	53
 Graphic Catalogue :	
Form 1 : State Icons And Meanings .....	17
From 2 : Dual Images Input Source Conflict List .....	31

# Briefs

Thanks for your purchasing our LED Video processor. Do hope you can enjoy the experience of the product performance. The design of the LED video processor conforms to international and industry standards. But if with improper operation, there will be a personal injury and property damage. In order to avoid the dangerous, please obey the relevant instructions when you install and operate the product.

## Trademark Credit

---

- VGA and XGA are the trademarks of IBM.
- VESA is a Video Electronics Standards Association's trademark.
- HDMI、HDMI mark and High-Definition Multimedia Interface are all from HDMI Licensing LLC
- Even if not specified company or product trademarks, trademark has been fully recognized

## About Software

---

Do not change, decompile, disassemble, decrypt or reverse engineer the software installed in the product, these acts are illegal

## Features

---

- Support ultra-high input/output resolution, it achieves pixel to pixel display more conveniently
- Support input signal single machine and multi-machines hot backup, allows you to be no longer embarrassed in case of sudden loss of the input signal
- Support preview image function, it switches the images more conveniently

- Support DP signal input, output, loop out , support DP 1.1 and DP 1.2 versions
- Support multi template operation, it can save 8 templates for call
- Support 32 offline tasks, it can load templates and switch channels as presetting
- Support customized input resolution, maximum 3840 pixels at horizontal or by vertical, maximum refresh rate 121Hz
- Support network function, the principal computer can control LED-570E series processors by network.

# Using Directions

## Including Accessories

Using manual

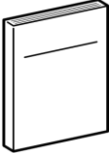

Power line

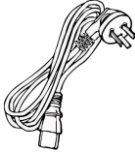

DVI signal cable

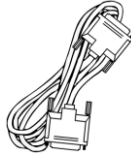

USB cable



232 serial line

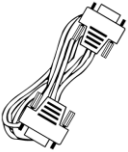

Big port DP cable



Mini DP cable



Composite Video Cable



M3 screws x 4

Sending card stud bolts

4pin 2.54 sending card power cable

Disk



Certification of quality



## Extended Port

---

Port		Model	Explanation
Input port	Extended VGA port	LED-570EV	Add another VGA input port
	Extended DVI port	LED-570ED	Add another DVI input port
	Extended SDI port	LED-570ES	Add another SDI input port/loop port
Output port	Extended DVI port	LED-572E	Add another DVI 3 and DVI 4 output port
	Extended VGA port	LED-573E	Add another VGA and DVI output port
	Extended SDI port	LED-575E	Add another SDI output port

## Safety Instructions

---

- Please use the correct power supply according that the power input voltage for this product range is 100 ~ 240V AC, 50/60Hz.
- When you need connect or pull out any signal or bound guideline. Please confirm that all the power supply cords have been pulled out ahead.
- When you need to add hardware device for the LED video processor, make sure all of the signals and power cables have been pulled out ahead.
- Before you operate any hardware, please turn off the LED video processor's power, and to set you on the electrostatic by touching the ground surfaces.
- Please use the processor in clean, dry and ventilated environment, not use it in the high temperature, humidity environment.
- The product is the electronic product; please stay away from the fire, water and of which is inflammable and blast, dangerous.
- This product is with high pressure components, please don't open the case or maintain it by your own.
- As there is exceptional condition with smoke, ill-smelling, please turn off the switch at once and contact with the dealers.



# Function Introduction

## Brief

LED-570E series products are the video processor developed for the large screen display system, adopted the top image processing chips, internal 12 bits processing, with clearer images and richer colors. The display bandwidth and processed bandwidth are several times of previous processors, it supports DP input.

Advanced alternate motion picture processing technology, to remove video motion tail or jagged, for the normal PAL/NTSC video, output image will be clearer, for the HD 1080i signal, output image details will be rich, full color and image quality is in the leading level.

Advanced image scaling technology, support user-defined output resolution, single machine support horizontal resolution 3840 at maximum, vertical resolution 3840 at maximum, refresh frequency rate 121Hz , can upgrade the output signal bandwidth utilization greatly; furthermore, also can use the traditional standard output resolution, then scaling the output image by pixel to pixel according to the real size of the LED screen.

Accurate dual pictures crop function, can achieve pixel to pixel display and material fusion easily.

Perfect video image input port, including 1×VGA(can be extended for two input in unison)、1×DVI(can be extended for two input in unison)、1×DP、1×HDMI、2×Video ( PAL/NTSC )、1×SDI(optional) , support all HD signal input, can be connected with various audio and video equipment.

Support seamless switching of multi input signals and PIP function.

# Front Panel Graphical Representation

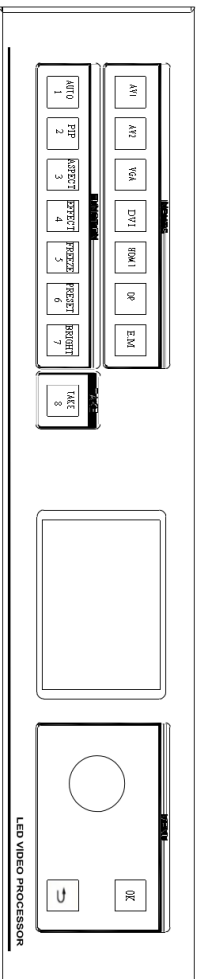

Buttons Introduction			
AV1	CVBS1 input port	Hold Knob	Choose menu items and adjust parameters
AV2	CVBS2 input port	AUTO/1	Numeric Key 1, auto adjust VGA input image position,
VGA	VGA input port	PIP/2	Numeric Key 2, dual pictures function shortcut
DVI	DVI input port	ASPECT/3	Numeric Key 3, the aspect ratio for output window adjusting shortcut
HDMI	HDMI input port	EFFECT/4	Numeric Key 4, the cycle of fade in /fade out adjusting shortcut
DP	DP input port	FREEZE/5	Numeric Key 5, image freeze key
E.M.	Expand input port	PRESETS/6	Numeric Key 6, modes saving and loading shortcut
OK		BRIGHT/7	Numeric Key 7, brightness menu opening shortcut
	Return	TAKE/8	Numeric Key 8, image 1 and image 2 switching shortcut
Press Knob	Same as the confirmed key		

# RearPanel Graphical Representation

LED-572E Rear Panel

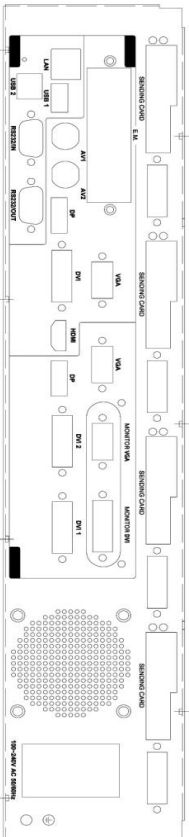

LED-573E Rear Panel

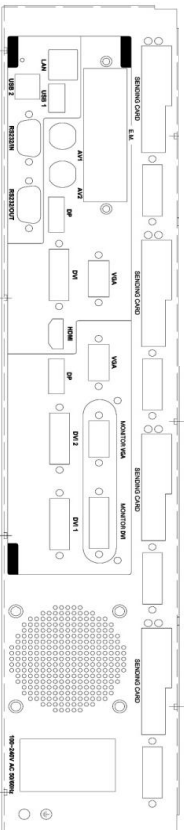

LED-575E Rear Panel

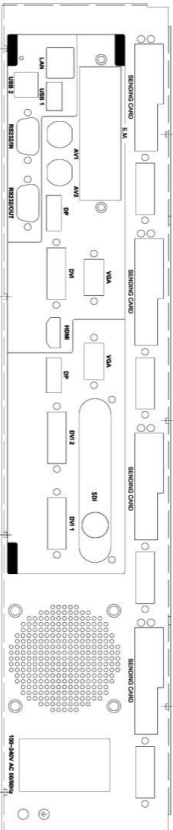

Video Input Ports	
AV1-AV2	2 way video Input Ports
VGA	VGA Input Port
DVI	DVI Input Port
HDMI	HDMI Input Port
DP	DP Input Port
E.M.	Expand Input Port, <u>check details in the <a href="#">"Extended Port"</a> list</u>

Video Output Ports	
VGA	VGA Output Port
DVI1~DVI2	2 way DVI Output Ports
DP	DP Output Port ( Support DP Loop Out )
DVI3~DVI4	2 way expand DVI Output Port, model LED-572E
MONITOR VGA	1 way expand preview VGA Output Port, model LED-573E
MONITOR DVI	1 way expand preview DVI Output Port, model LED-573E
SDI	1 way expand SDI Output Port , model LED-575E

Sending card plugs	
Qty.	4 sending card plugs

# Technical Specification

---

Input Indicators		
Port	Number	Resolution
CVBS	2	PAL/NTSC/SECAM
VGA	1+1 (inhere 1 way, scalable 1 way)	1024 × 768/60Hz、1280 × 1024/60Hz etc VESA Standard
DVI	1+1 (inhere 1 way, scalable 1 way)	1024 × 768/60Hz、1920 × 1080/60Hz etc VESA Standard, also support customized resolution
HDMI	1	EIA/CEA-861, HDMI-1.3
DP	1	Display Port 1.1、1.2
SDI	1 ( E.M. )	480i/60Hz、576i/50Hz、720p/60HZ、1080i/50Hz、1080i/60Hz、1080p/60Hz ( 3G SDI )

Output Indicators			
Port	Number	Resolution	
VGA※	1	<b>2K×1K Resolution :</b> 1024×768/60Hz 1280×1024/60Hz 1280×720/50Hz/60Hz 1440×900/60Hz 1600×1200/60Hz 1600×1200/60Hz-Reduced 1680×1050/60Hz 1920×1080/60Hz      1920×1080/50Hz 1920×1200/60Hz      2560×816/60Hz 2048×1152/60Hz      2304×1152/60Hz 1536×1536/60Hz      1024×1280/60Hz <b>2K×2K Resolution :</b> 2560×1024/60Hz      2560×1600/60Hz 2560×1440/60Hz      1080×3840/60Hz 3840×1080/60Hz      1920×1080/120Hz 1920×1080/100Hz	
DVI	2+2 ( inhere 2 way, scalable 2 way )	Customized output resolution ( Bandwidth optimized ) :	
DP	1	Horizontal resolution 3840 at maximum	
DP Input Looping Out	1	Vertical resolution 3840 at maximum	
SDI Input Looping Out	1	In accordance with DP input	
SDI	1 way extensible	In accordance with SDI input	
		480i/59.94Hz	480i/60Hz
		576i/50Hz	720p/50Hz
		720p/60Hz	1080i/50Hz
		1080i/59.94Hz	1080i/60Hz
		1080p/23.94Hz	1080p/24Hz
		1080p/25Hz	1080p/29.97Hz
		1080p/30Hz	1080p/50Hz
		1080p/59.94Hz	1080p/60Hz

※ VGA support 2K×1K Standard only

Complete Machine Specification	
Input Power Supply	100-240V AC~50/60Hz 0.8A
Working Temperature	0-45°C
Overall Dimensions	482.0×354.3×66.8 mm (L × W × H)
Net Weight	4.5Kg

# Using Menu

Using the menu system can set to this machine convenient and intuitive to meet the demands of user.

LED-570E series products using a full color LCD screen to display the whole user menu. If the user does not have operation or operation timeout, the LCD screen will show the default state. Operate the menu system by using the knob and keys. The user can check and set its function and states convenient and intuitive to meet the demands.

We will combine the keys function and LCD screen display, detailed introduces you to LED-570E series products menu system.

## How to use the keys

The front panel keys of LED-57X series products are divided into three areas: INPUTS, MENU and FUNCTION.

### **INPUTS area :**

This area contains seven keys : AV1, AV2, VGA, DVI, HDMI, DP and E.M.

In the menu system default state, press the keys in this area can switch the input signal source 1 to the corresponding input port.

### **MENU area :**

This area contains 2 press buttons: a confirmation key(OK), a return key( ➡) and a knob which can be pressed. Press the "knob", its function is same as the confirmation key; long press the "knob", can make the menu system return to the default state immediately; when to press return key, the menu system may be back to the higher level menu in turn until returning to the default state. In the main menu, OK key is also used in the switching between the two modes below:



Browse mode	Setting mode																
<table border="1"> <tr> <td>Picture mode</td> <td>Normal</td> </tr> <tr> <td>Brightness</td> <td>50</td> </tr> <tr> <td>Contrast</td> <td>50</td> </tr> <tr> <td>Color</td> <td>50</td> </tr> </table>	Picture mode	Normal	Brightness	50	Contrast	50	Color	50	<table border="1"> <tr> <td>Picture mode</td> <td>Normal</td> </tr> <tr> <td>Brightness</td> <td>50</td> </tr> <tr> <td>Contrast</td> <td>50</td> </tr> <tr> <td>Color</td> <td>50</td> </tr> </table>	Picture mode	Normal	Brightness	50	Contrast	50	Color	50
Picture mode	Normal																
Brightness	50																
Contrast	50																
Color	50																
Picture mode	Normal																
Brightness	50																
Contrast	50																
Color	50																
↖ OK key, press the knob, can switch the two modes ↗																	

In the browse mode, anti-clockwise "knob", the cursor moved to the above or the left. Clockwise "knob", the cursor moved to below or right. Put the cursor to the item need to adjust, press the "knob", or confirm key, namely into set mode, then anti-clockwise "knob", can reduce the current parameter value. Clockwise "knob", it can increase the current parameter values. If you want to continue to set this page other item, please switch back to browse mode. If you need to return to the higher level menu, please use the return key. If finish the adjustment, can long press "knob" to back to the default state directly, or wait for system overtime, automatic return the default state (in some special interface, the system will not be back to the default state, for example, image switch fast interface, user mode fast interface, test picture interface, etc.).

### FUNCTION area :

There are 8 keys in this area: AUTO, PIP, ASPECT, EFFECT, FREEZE, PRESETS, BRIGHT and TAKE.

Key	Default Menu State
AUTO	Automatically rectify the image display position when the current input source is VGA.
PIP	Open or close the function of PIP
ASPECT	Open the interface of aspect ratio, it can adjust the aspect ratio for output window
EFFECT	Open the image switching menu, it can adjust the cycle of fade in/fade out
FREEZE	Freeze the current image

PRESETS	Open the mode interface, it can save and load modes
BRIGHT	Open the brightness interface
TAKE	When PIP function is on, it can switch image 1 and image 2

## Default state introduction

Turn on the power supply of LED-570E series processors, in the process of the system startup, the LCD front panel would display the start interface on the left screen, when the start completed, there will show the machine' s current state on the screen as the following figure 1 shows:

Figure 1 default state interface after startup

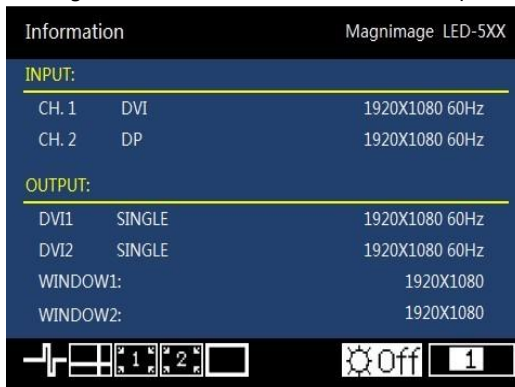



The explanation for above figures are as below:

Items	Explanation
CH.1	Image 1 (main image, is also default image) port name and current input signal resolution.
CH.2	Image 2 (vice image) port name and current input signal resolution
DVI1	Output port DVI1 output resolution
DVI2	Output port DVI2 output resolution
WINDOW 1	size of image 1 output window
WINDOW 2	size of image 2 output window

The last line in above figure 1 is status prompt area, by several icons to show

the machine current working status. Pls see the below form 1:

Icons	Area	Name	Hint(shortcut key in the bracket)
	1	Synchronism follow-up state area	When the Mosaic function is in opening state, Synchronism follow-up is also started successfully
	2	Mosaic state	mosaic function is on
	3	Image 1 Crop Off	Image 1 Crop function is off
	3	Image 1 Crop On	Image 1 Crop function is on
	4	Image 2 Crop off	Image 2 Crop function is off
	4	Image 2 Crop On	Image 1 Crop function is on
	5	Lock to Screen	The aspect ratio of output image is locked by aspect ratio of output resolution
	5	Full screen	The output image is displayed in full screen
	5	16:9	The aspect ratio of output image is 16:9
	5	5:4	The aspect ratio of output image is 5:4
	5	4:3	The aspect ratio of output image is 4:3
	5	3:2	The aspect ratio of output image is 3:2
	5	1:1	The aspect ratio of output image is 1:1
	5	Custom	User can customise the size for output image
	6	EDID	The DVI input resolution is customized resolution
	7	Image freeze state	Image is frozen
	8	Brightness grade icon	Digital presents current brightness grade, range from 0-16 or OFF(BRIGHT)
	9	PIP Off	PIP function off (PIP)
	9	PIP On[1]	PIP function on , picture 1 is on the top (PIP)

	9	PIP On[2]	PIP function on , picture 2 is on the top (PIP)
	9	multi-screen display for image 1	Image 1 display on multi-screens
	9	multi-screen display for image 2	Image 2 display on multi-screens

## Main menu introduction

The main menu will show the symbols listed in the table below, please check its specific meaning in the table below:

Symbol	Explanation
	Press "knob" or "OK" to enter the detail setting page

In the main MENU, the user can use the "KNOB", "OK", "" and other ten number key to select and adjust the each item. Its operation is fixed pattern, please check the following table:

Operation	Key
Open the main menu	Press "OK" in the default state
Select item	Rotate "knob" to select item
Adjust parameters	When there is "▶" on the right of item, rotate "knob" to adjust the parameters
Enter next level menu	When there is "▶" on the right of item, press "OK"
Performs	Use "knob" to select the operation item, press "OK"
Back to higher menu	Press "↩" key
Confirm	When the reset operation, to avoid the incorrect operation, need to use the "OK" key to confirm operation

## Main menu

In the default state, press "OK" or "knob" to enter the main MENU state, the LCD screen will show the details as below:



The main menu has twelve sub menu items, divided into three pages display. Rotating "knob" to select the above listed twelve sub menu title, after selected, press "OK" button to enter the selected project, press "↵" to be back.

## Picture setting sub menu

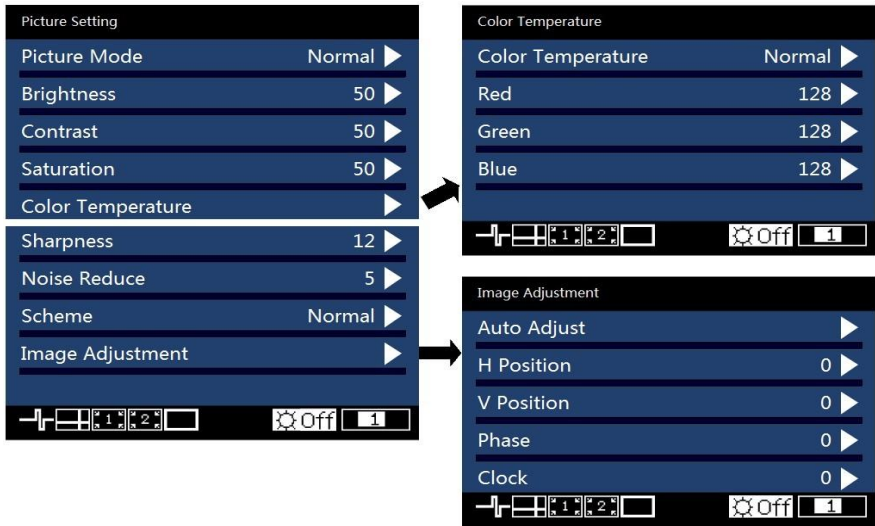

Picture Mode	Divided into "User" 、 "Vivid" 、 "Soft" 、 "Normal" the four options.
Brightness	Range 0~100
Contrast	Range 0~100
Saturation	Range 0~100
Color Temperature	Divided into "Normal" 、 "Warm" 、 "Cool" 、 "User" the four options.
	Red Range 0~255
	Green Range 0~255
	Blue Range 0~255
Sharpness	Range 0~24
Noise reduce	Range 0~63
Scheme	Divided into "Normal" 、 "Vivid" 、 "Theatre" 、 "Game" 、 "Sport" five modes.
Image Adjustment	It is valid when image 1 input signal is VGA or Ext.VGA, automatically to adjust the position and size of input image. This moment, should ensure input image to be full screen and with a bright edge.

## Output setting sub menu

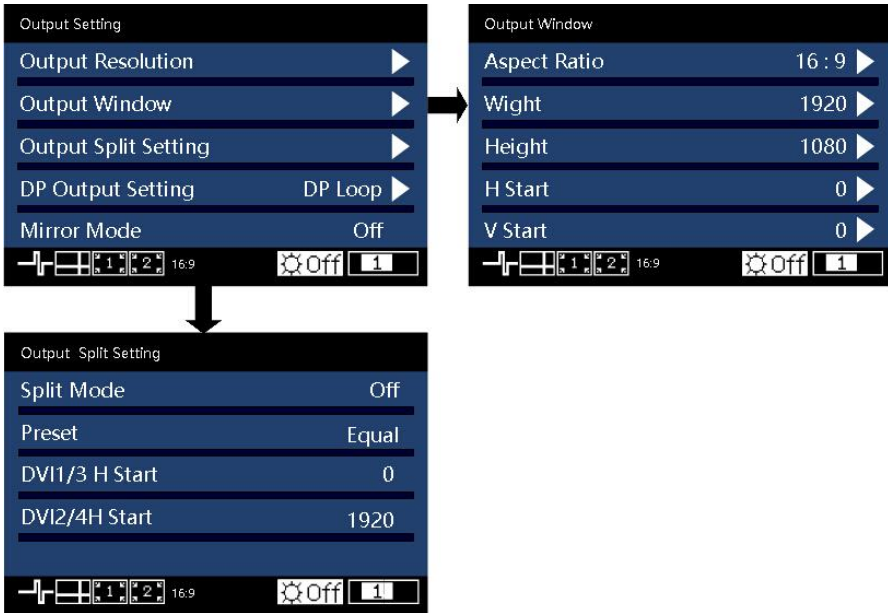

Output Resolution	LED-570E series products support 23 kinds of regular output resolution, also support customized horizontal/vertical parameter of output resolution. It supports horizontal resolution 3840 at maximum, vertical resolution 3840 at maximum, refresh rate 121HZ at maximum. Find details in "output indicators" .	
	Aspect Ratio	Divided into "Lock To Screen" , "16:9" , 5:4" , "4:3" , "3:2" , "1:1" , "Custom" and "Full screen"
Output Window	H Window	Minimum 204, Maximum is "the width of the current output resolution" ( take 1024×768 60Hz for example, 1024 is the H window )
	V Window	Minimum 48, Maximum is "the height of the current output resolution" ( take 1024×768 60Hz for example, 768 is the V window )
	H Position	Minimum 0, the biggest can be set to the differentials



		between" the width of the current output resolution" and "H Window"
	V Position	Minimum 0, the biggest can be set to the differentials between" the height of the current output resolution" and "V Window" .
Output setting	split	The default is off when the two outputs are not spliced;Two outputs splicing , preset default is equal.Applies to the case of the right of the screen is larger than the left side of the screen.By changing DVI2 / 4 H start to reach the screen mosaic effect, the DVI2 / 4 H start is the pixel to the left of the screen.
DP output setting		Divided into "iDP" and "DP loopout" .
Mirror Mode		"On" or "Off" the mirror mode, default is off

Please set the output resolution, H width and V height based on the physical resolution of LED screen. If do not have suitable output resolution, please select the options with bigger resolution than the reality. Or to choose the customized output resolution, to connect with the LED screen pixel to pixel directly.

For example, the resolution of one LED panel is 1152×960, the closet resolution is "1280×1024 60Hz", so please set the output resolution as "1280×1024 60Hz" . Furthermore, it needs to set the width as the actual width of LED panel, which is "1152" . Likewise, set the height as the actual height of LED panel, which is "960" . And we also can define the output resolution, set the width and height as 1152 and 960,then it can output resolution "1152×960" directly.

**Note 1:** please use the bigger than 60Hz refresh rate or greater height and width pixel output resolution judiciously, it is not sure that the back-end equipment can support this resolution.

**Note 2:** customized output resolution is not the standard output signal, part of the monitor may not be able to identify, but does not affect the LED display, please use carefully.

## Video crop sub menu

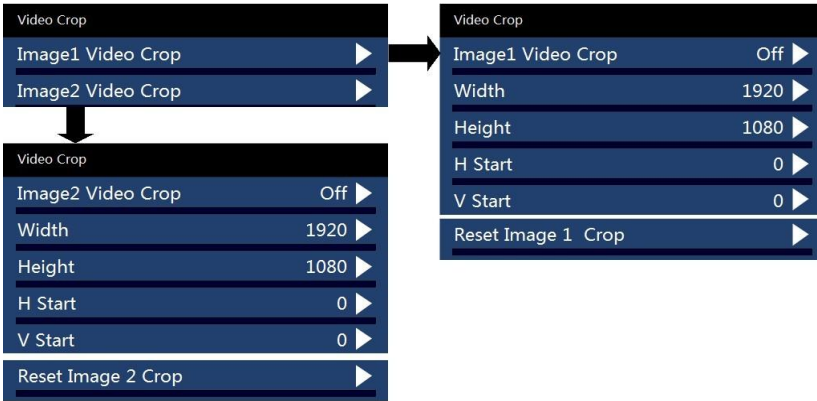

Image 1/2 Crop	"On" or "Off" the video crop function for image 1/2, default is off
Width	Minimum value is 32, maximum value is the "input signal width" .
Height	Minimum value is 32, maximum value is the "input signal height" .
H Start	Minimum value is 0, the biggest can be set to the differentials between "input signal width" and "Width" .
V start	Minimum value is 0, the biggest can be set to the differentials between "input signal height" and "Height" .
Reset	Reset above four parameters.

LED-570E series products support dual image video crop.

Image crop function is crop the input signal and output it to LED panel as output setting. So the size and position of crop window is limited within the input window. All the parameters in above form restricts mutually.

Additional remarks: input signal width, height and other information can be checked in display of "current input signal resolution specification" [Default State](#)" [📖 16].

For example, if the input resolution for image 1 is 1920×1080 60Hz , then the width of input signal is 1920 , the height is 1080 , refresh rate is 60Hz.

## Image Switching sub menu

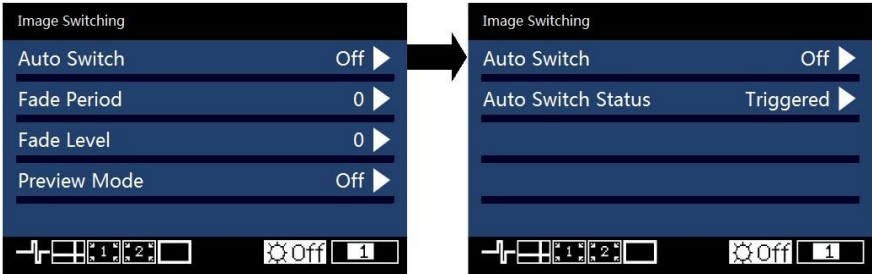

Auto Switch	Off	Auto switch function is closed.
	Window 1	If the image 1 input signal effective, the image 1 is on the top.
	Window 2	If the image 2 input signal effective, the image 2 is on the top.
	Signal	The effect input signal picture is on the top.
Cycle of fade in / fade out	Range 0~4, adjust the cycle of fade in / fade out.	
Grade of fade in / fade out	Range 0~16, use “knob” to switch fade in fade out by hand	
Preview mode	“On” or “Off” the preview mode, default is off. When the preview mode is on, DVI1 will display the sub channel signal.	

## Mosaic sub menu



Image 1 Mosaic	Image 1 mosaic "On" or "Off" , default is off
H Total	The physical pixel points of the LED screen in horizontal direction.
V Total	The physical pixel points of the LED screen in vertical direction.
Width	The pixel points that the display area of the current video processor shown in the horizontal direction.
Height	The pixel points that the display area of the current video processor shown in the vertical direction.
H Start	The level starting position of the display area that controlled by the current video processor. The LED screen top-left corner is viewed as the original point (horizontal starting point 0).
V Start	The vertical starting position of the display area that controlled by the current video processor. The LED screen top-left corner is viewed as the original point (vertical starting point 0).
Sync Mode	Divided into "Mode 1" , " Mode 2" and "Mode 3" . Mode 1 The image jittered slightly, the synchronous effect is slight. During the mosaic process, if the "Mode 1" can't synchronize, please choose "Mode 2" . Mode 2 Image jitter is in the middle between 3 modes, the synchronous effect is also the middle one between 3 modes. During the mosaic process, if the "Mode 2" can't

---

synchronize, please choose "Mode 3" .

---

Mode 3

The image jittered strongly, and the synchronous effect is the best.

---

## Communication sub menu

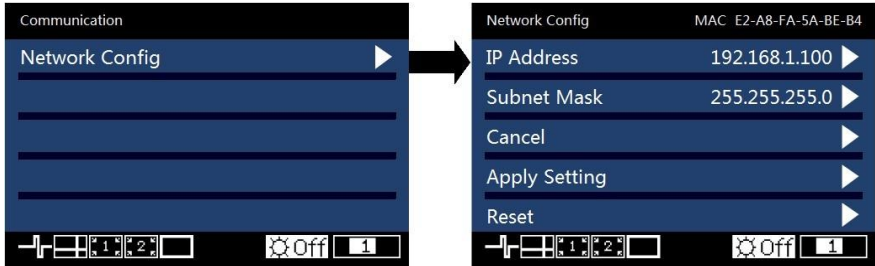

---

MAC	E2-A8-FA-5A-BE-B4	The default MAC address for this products
-----	-------------------	---

---

IP address	Default address 192.168.1.100
------------	-------------------------------

---

Subnet Mask	Default address 255.255.255.0
-------------	-------------------------------

---

Network Config

Cancel	Cancel the current adjusting to IP address and subnet mask address, return to the preview status
--------	--

---

Apply Setting	Apply the previous setting, after confirm, it return to main menu
---------------	---

---

Reset	Reset the network configures to default status.
-------	---

---

## Task manager sub menu

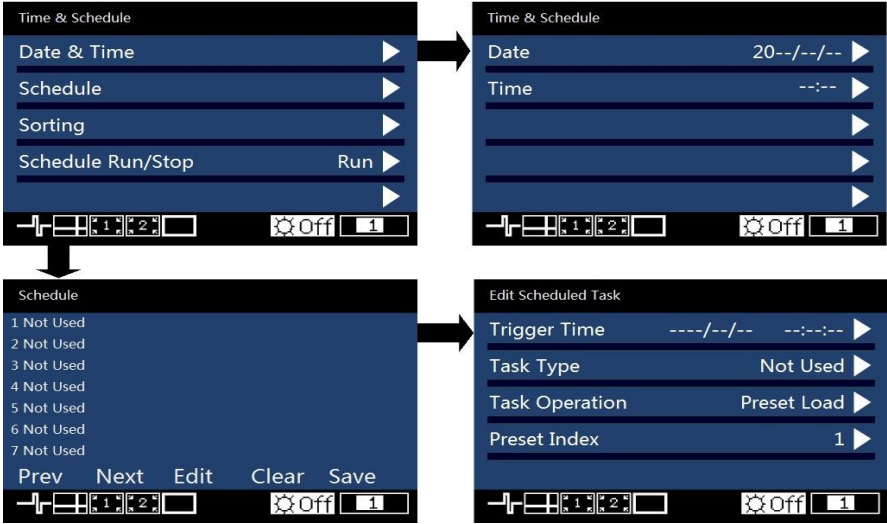

Date & Time	Date	Set the date
	Time	Set the time
Schedule	Serial no.	Task number, it can set total 32 tasks
	Trigger time	Set the start date and time
	Task type	It contains "unused", "only once", "everyday", "every week/within 24h", "cycle/each 24h", "cycle"
	Task operation	Divided into "Call preset template" and "switch channel" .
	Preset template no./Target no.	Choose the preset template no. ( 1-8 )/Choose the channel which will switch to ( CVBS1, CVBS2, VGA, DVI, HDMI, DP, E.M. )
	Cycle	Set task type cycle 1-480mins.
Sorting	Sort the tasks.	
Schedule Run/Stop	"Run" or "Stop" the time & schedule function	

## Misc sub menu

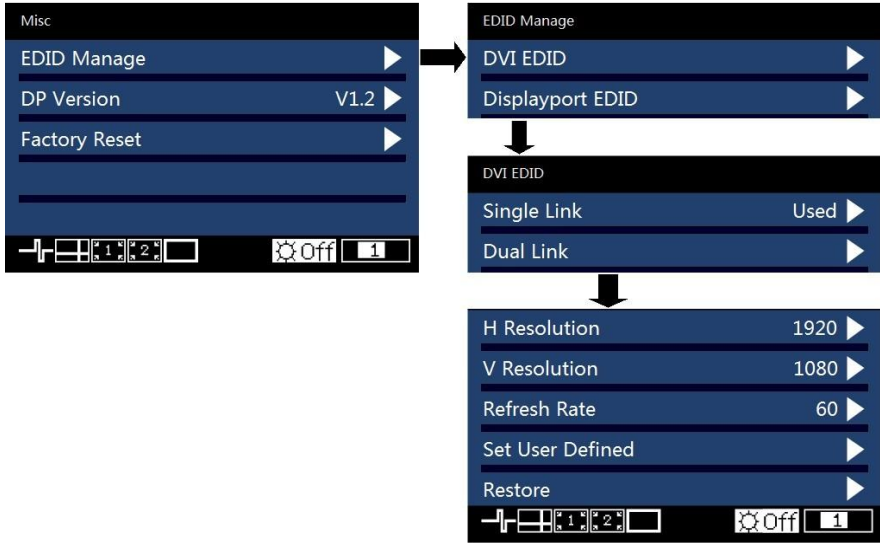

EDID manage	DVI EDID	Set the EDID for DVI input.
	Display Port EDID	Set the EDID for DP input.
DP Version	Choose the DP version, it has V1.1 and V1.2	
Factory reset	Restore all settings to default.	

## Dual image setting sub menu

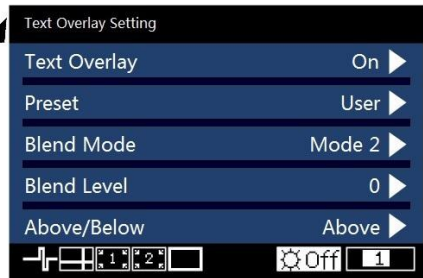
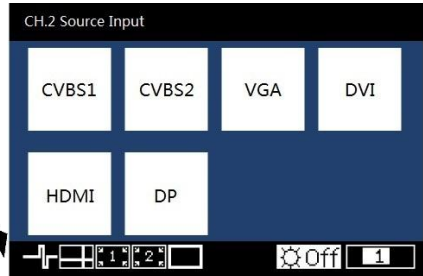

Dual Image	Dual image function is "On" or "Off", default is off.
Width	The horizontal width of vice image, and the minimum value is 204, maximum value is "the current resolution width" .
Height	The vertical height of auxiliary image, and the minimum value is 48, maximum value is "the current resolution height" .
H Start	The horizontal coordinates for top-left corner of auxiliary image in "output resolution window" .
V Start	The vertical coordinates for top-left corner of auxiliary image in "output resolution window" .
Source input	Switching input port of image 2 ( sub channel ) . This item is limited by image 1 input source, details in the " <a href="#">dual images input source conflict list</a> " .
Text overlay setting	Text overlay, cutout synthesis menu, check details in the "text overlay specification" .



## Form 2 : Dual images input source conflict list

Image 1 Image 2	AV1	AV2	VGA	DVI	HDMI	DP	E.M.
AV1	√	×	*√	*√	*√	*√	×
AV2	×	√	*√	*√	*√	*√	×
VGA	√	√	√	√	√	√	√
DVI	√	√	√	√	**√	√	√
HDMI	√	√	√	**√	√	√	√
DP	√	√	√	√	√	√	√
E.M.	×	×	√	√	√	√	√

**Note 1:** During the above graph with "\*" combinations, because the image 2 didn't go interlaced processing, there will be a slight shaking phenomenon in the screen, in this kind of circumstance, can consider exchange image 1 and image 2 input source.

**Note 2:** "\*\*\*" When the DVI input is dual link mode, the input source DVI and HDMI are conflict.

**Note 3:** During switch input port, the system to image 1 for priority, if image 2 port and image 1 port conflict with each other, image 2 will be switched under the image 1 automatically.

Text Overlay specification	
Text overlay	Text overlay function "Open" and "Closed". The default is closed.
Preset	It contains 12 modes (black background white words 1,2 ;white background black words 1,2; black background green words 1,2 ; white background green words 1,2; black background red words 1,2; white background red words 1,2) and user-defined mode
Blend Mode	Divided into "Mode1"and"Mode2" two patterns.
	Mode1 : In this mode the text pixels are on top and not blended. The non-text pixels are blended with the other channel using the Transparent setting in Dual Image sub Menu.
	Mode2 :In this mode the text pixels are blended with the other channel using the Transparent setting in Dual Image sub Menu. The non-text pixels are completely transparent.

Blend level	Set the transparency of image, range "0—15" .
Above/Below	Above : The pixel that has any color value above the Red, Green and Blue level become tagged as TEXT PIXELS, the rest of the pixels becomes NON-TEXT pixels. The judgment should be combined with the "And/Or" conditions.
	Below : The pixel that has any color value below the Red, Green and Blue level become tagged as TEXT PIXELS, the rest of the pixels becomes NON-TEXT pixels. The judgment should be combined with the "And/Or" conditions.
And/Or	And : all three color must be used to trigger the above / below comparison
	Or : any color is enough to trigger the above / below comparison
Red	Red Threshold, Range: 0~255
Green	Green Threshold, Range: 0~255
Blue	Blue Threshold, Range: 0~255

## Test pattern sub menu

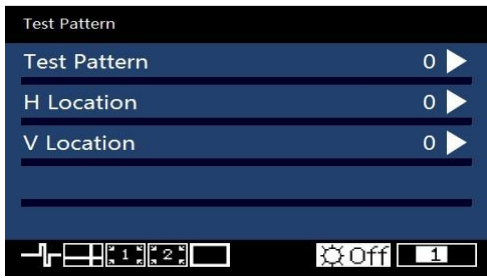

---

Test pattern      Range 0~72. 0 means no test pattern display , 1~72 means test pattern number.

---

※H Locating      The valid range minimum value is 0; maximum value is the horizontal width of the current output resolution.  
 To determine the horizontal position of the cursor on the screen, "-1", close the cursor.

The valid range minimum value is 0, maximum value is the vertical height of the current output resolution.

※V Locating To determine the vertical position of the cursor on the screen, "-1", close the cursor.

\*: "H position" and "vertical position", as long as there is a numerical for "-1", in the picture will not display the positioning cursor.

## Language sub menu



English The menu will display in English.

繁體中文 The menu will display in traditional Chinese.

简体中文 The menu will display in simplified Chinese.

# Input signal hot backup

## Summarize

- Note that what the input signal hot backup is? What is the use of it?
- In simple terms, warm backup is that when the input signal missed, using spare
- input signal automatically and rapidly to replace the original input signal, maximum
- ensure output image uninterrupted.
- Hot backup is a powerful guarantee to the stability of the system, which makes the impact to be the lowest that made by signal input device failure.

## How to use hot backup?

Enter the “image switching sub menu” and select “auto switch” function, you can set how to use LED-570E series video processors hot backup function here. Here are four options, for details please refer to the table below:

Item	Details
Off	Not to use the heat backup function.
Window 1	If image 1 signal is valid, then output image 1, otherwise, output image 2.
Window 2	If image 2 signal is valid, then output image 2, otherwise, output image 1.
Signal	In the case of two channels signal are invalid, the first valid of the two channels signal, then its image will be output, the behind signal does not affect the output.

Note that when you use the hot backup function, location and size of image 1 or image 2 output screens should be set in advance according to actual use. Recommend using "Window 1" option, set the backup sources to the image 2. Hot backup is the operation based on the signal detection, when the signal source is unstable or lost moments, there will be instant black screen, but within the fastest time (around 0.2 seconds), backup channel image will be displayed, let picture interrupt time reduced to a minimum.

Our LED-570E series processors support multi machine hot backup. When several machines are connected, and if one or some of them missing signal, all machines switch to the hot backup signal and display the image rapidly, this allows you to be no longer embarrassed in case of sudden loss of the input signal.

# Setting EDID

## EDID Summarize

In order to make PC or other image output equipments to output the required resolution, LED-570E series processors add the EDID function. It contains DVI EDID and DP EDID.

## How to set EDID

Item	Details
H Resolution	Set the horizontal pixel points of resolution
V Resolution	Set the vertical pixel points of resolution
Refresh rate	Set the refresh rate of resolution
Set user defined	Set user-defined resolution
Restore	Reset to default resolution

Enter "Misc sub menu" and select "EDID Manage", choose the items "DVI EDID" and "DP EDID" according to your requirement, (if there is expanded DVI, it also can set the expanded DVI EDID). Set the horizontal pixel points, vertical pixel points and refresh rate for resolution as your request, then select "set user-defined resolution".

### Setting DVI EDID :

If the processor always use DVI previously, it can set directly, after finish the setting, restart it or plug the signal.

### Setting DP EDID :

If DP changed the version between 1.1 and 1.2, it need to restore the EDID before setting, then after finish the setting, plug the signal or restart it.

# iDP & DP Loop

## iDP & DP Loop Summarize

LED-570E series processors pack all the output signal into DP signal, that is iDP; the input DP video signal output from DP output port directly, that is DP Loop. The DP ports of LED-570E series processors support two versions V1.1 and V1.2.

## How to use iDP & DP Loop?

Under the “Output setting” menu, you can choose “iDP” or “DP Loop” output.

Under the “Misc” menu, you can choose DP Version “V1.1” or “V1.2” .

iDP output diagram (DVI is the main input channel) :

The images 1, 2 are same as DVI input, the image 2 (DP output image) will change follow the image of main channel under iDP mode.

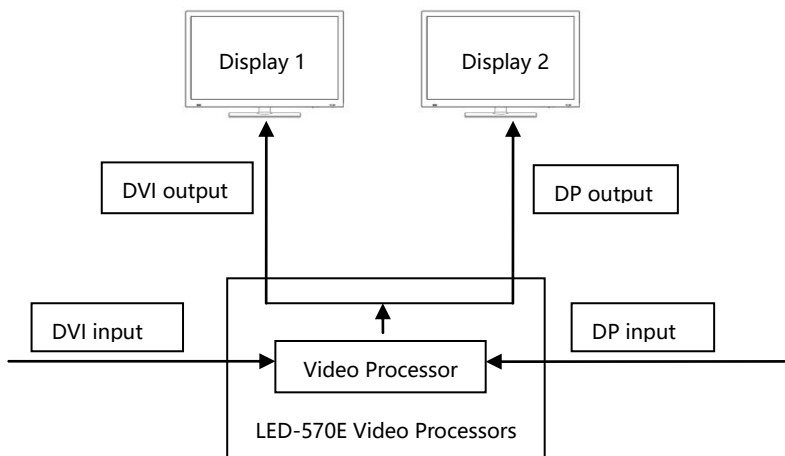

DP Loop output diagram (DVI is the main input channel) :

The image 1 is same as DVI input image, image 2 (DP output image) is same as DP input image won't change follow the image of main channel under DP Loop mode.

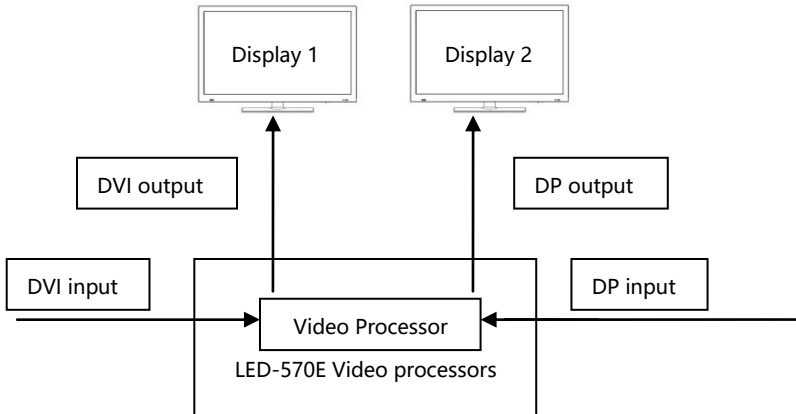



# Preview Mode

## Preview Summarize

When user needs to change the signal which is displaying to new one, we can preview the new images on another display, and confirm if the new images are workable, this function called preview.

## How to use preview?

Firstly, change the output resolution to 2K x 2K in the list of [“Output indicators”](#) ( 12 ) ( suggest 3840×1080/60Hz ); then enter the “Image switching” sub menu, select the “Preview mode” function on, then press “TAKE” button in “FUNCTION” area on front panel, open the TAKE menu, , it will show the information of displaying image(PROGRAM) and preview image (PREVIEW), please see below picture:



Under the TAKE menu, user can switch the signal source for “PREVIEW” (preview image) by the buttons in “INPUTS” area, when user switch it to the requested image, press “TAKE” button, change “preview image(PREVIEW)” to “displaying image (PROGRAM)” , the interface will be changed as below:



In the same way, if you need to change the displaying image, you can switch the preview image firstly, and after the preview image meets your request, press "TAKE" button, then the displaying image will change with preview image.

# Multi machine connection

With the large area, HD display time arriving, the LED display area usually will be beyond the sending card loaded area more, LED display project also is to realize by the way of using many screens and processors. However, with the increasing of the processors, let field control staff' s work also become complicated. For that, simplified site operation, LED-570E series processors have multi-machine connection function. Multi-machine connection function is as following: all machines recover to a certain work mode quickly, namely "multi-machine loading template".

## Connect type

On the lower-left of rear panel of LED-570E series processors, there are two RS232 series ports, one marked as "RS232/OUT" for communications signals send port; another is "RS232/IN" as a communication signal receiver port. In order to achieve multi machine connection, we need to connect all the processors according to following picture.

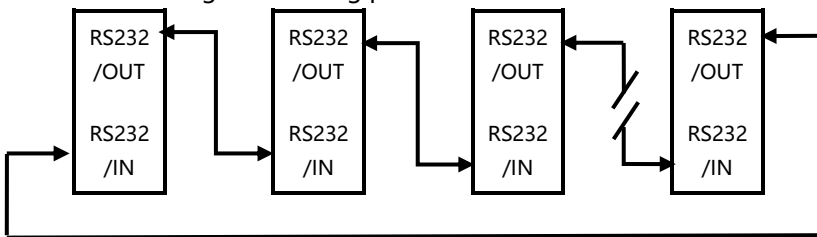

In the above diagram, the arrows represent RS232series port communicate cables, and communication signals are always from "RS232/OUT" port to "RS232/IN" port. This is a cyclic annular, its advantages are :

- A. Any of LED-570E series products can be a starting point of the communication signal, namely operating terminal can be arbitrary machine of the ring.
- B. Easily to add or remove one unit machine from the circular link structure.

## Multi machine load template

---

“PRESETS” menu and methods of using :

In the “[default state](#)” (  16 ),press “PRESETS” button, the menu system will enter the template loading status, please see below picture:

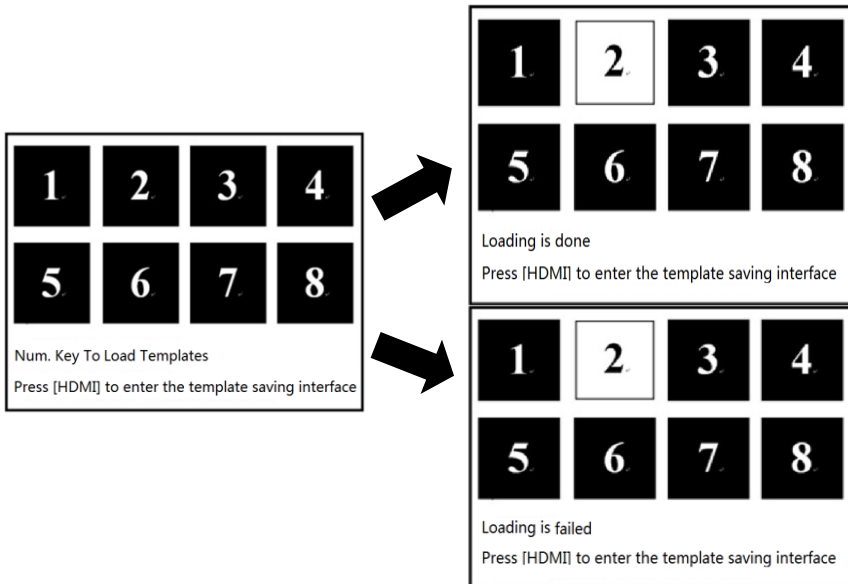

Press the numeric key at this time, if the number had been saving template in advance, then the before, the numeric key will be highlight and remind you that “loading is done” ; if the number hadn’ t been saved template, then the numeric key will be highlight and remind you that “loading is failed” .

When need to save templates, press “HDMI” button to enter the template saving interface, please see below pictures:

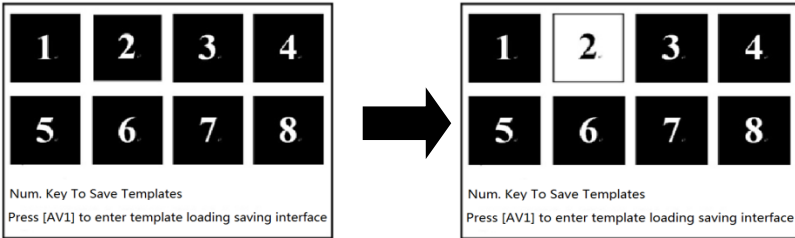

If the numeric key is highlight after you press it, it means the saving is done. When many machine state is established (i.e. connected the machines well according to the above mentioned "Multi machine connection mode" ), make sure all the machines are in "[default state](#)" ( 🗨 16 ) , to press " PRESETS" function shortcuts in any one LED-570E series front panel, all the machines will enter the template loading shortcut menu. Press any numeric key at this moment, all the machines will load the corresponding template to their own system, it is more convenient to switching for different applications.

# Single machine support mosaic within 4K

## DVI output port introduction

LED-570E series processors have 2 DVI output ports( DVI1、 DVI2). When the output resolution is 2K x 2K resolution in “[Output indicators](#)” list, it will output on multi displays, DVI1 will output the left part and DVI2 for right part, please see below diagram:

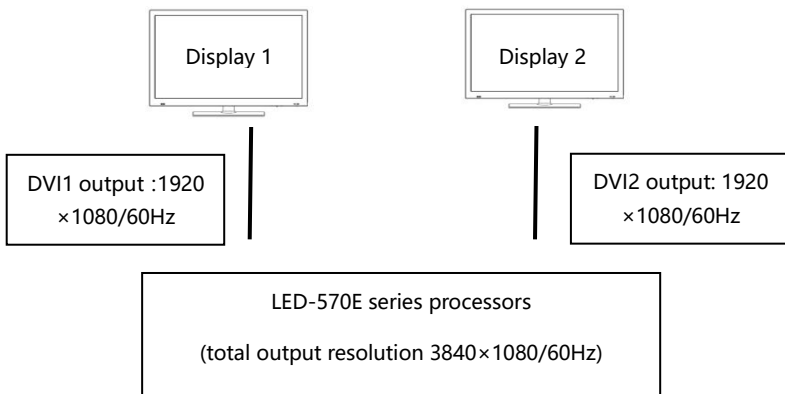

## Single machine support zoom mosaic within 4K

As LED-570E has multi display output function for high output resolution, and it also supports user-defined output resolution, it can achieve zoom mosaic for any resolution within 4K.

Methods of using :

If the width of LED panel is not matching the standard horizontal resolution, for example, LED panel 1: 1872x1040 , LED panel 2 : 1768x1040 , then we should mosaic them as below :

1. Firstly, we should calculate the total horizontal output resolution based on twice of the wider panel, then it should be 3744 x 1040.

2. Secondly, we should confirm the total horizontal output resolution based on the total width of two panels, then it should be 3640×1040.

Please see below diagram:

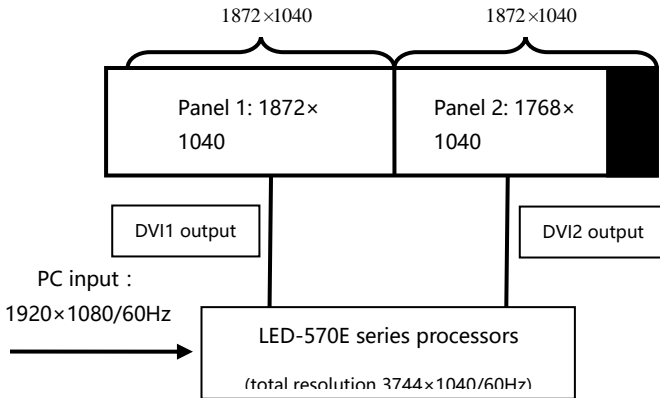

When use this single machine mosaic, the easiest way is put the wider panel on the left and the narrow panel on the right.

## Single machine support pixel-to-pixel mosaic within 4K

As LED-570E has multi display output function for high output resolution, and it also supports user-defined output resolution, it can achieve pixel-to-pixel mosaic for any resolution within 4K.

In order to achieve pixel-to-pixel display, it needs use “DP/HDMI” input function, and set “DP/HDMI” EDID function to make PC output required resolution, the left steps same as [“single machine zoom mosaic within 4K”](#) .

For example, LED panel 1:1280×1600, LED panel 2: 1024×1600, pls see below diagram:

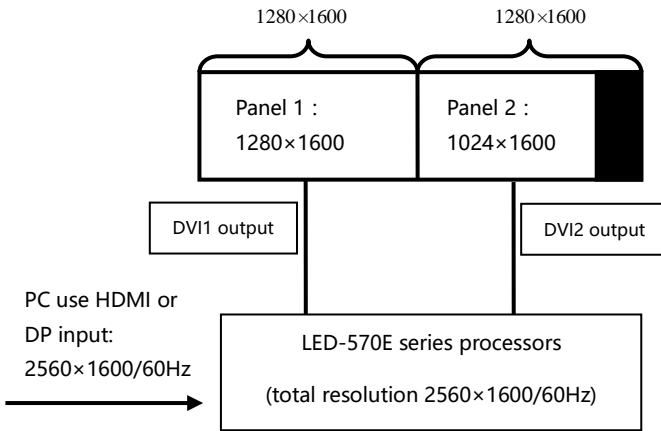



# Solutions

## Solution 1 : Support pixel-to-pixel mosaic within 4K\*2K

Three machines support pixel-to-pixel mosaic within 4K\*2K  
Full screen 3840×2160 , each panel 1920×1080.

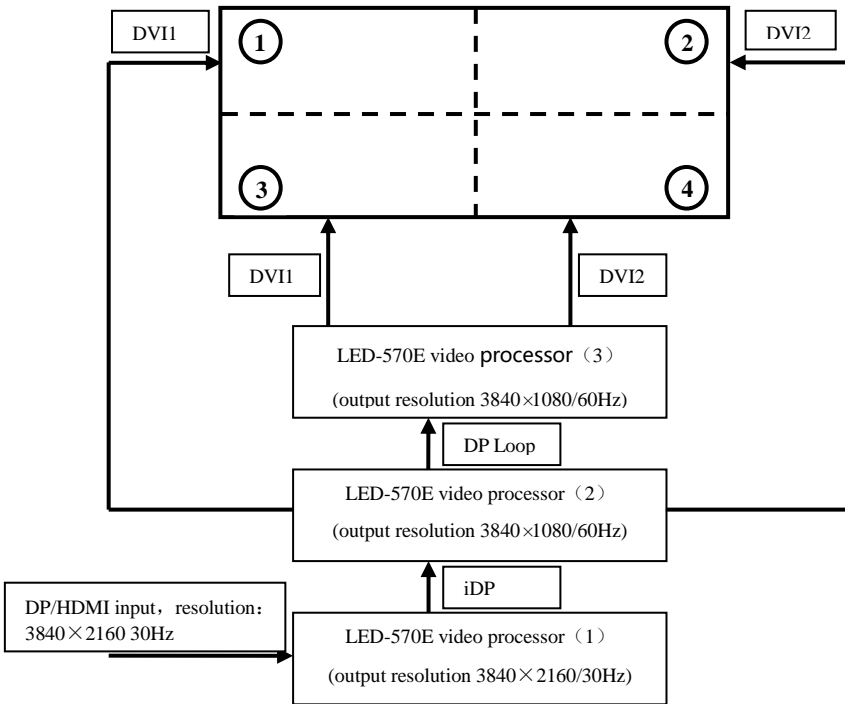

LED-570E ( 1 ) parameter setting :

DP output: iDP.

- 1、 Use "DP" input function, and set "DP" EDID function to make PC output required resolution : 3840×2160 30Hz
- 2、 Use "HDMI" input function, and set "HDMI" EDID function to make PC output required resolution : 3840×2160 30Hz

LED-570E ( 2 ) parameter setting :

DP output: DP Loop.

Output resolution: 3840×1080 60Hz , output window: 3840×1080

Image1 Mosaic :

Screen H Total	3840
Screen V Total	2160
Screen Width	3840
Screen Height	1080
Screen H Start	0
Screen V Start	0

LED-570E ( 3 ) parameter setting :

Output resolution:3840×1080 60Hz , output window:3840×1080

Image1 Mosaic :

Screen H Total	3840
Screen V Total	2160
Screen Width	3840
Screen Height	1080
Screen H Start	0
Screen V Start	1080

## Solution 2 : 1920×2160( pixel-to-pixel mosaic)

Single machine support pixel-to-pixel mosaic(1920×2160).

Full screen 1920×2160 , each panel 1920×1080.

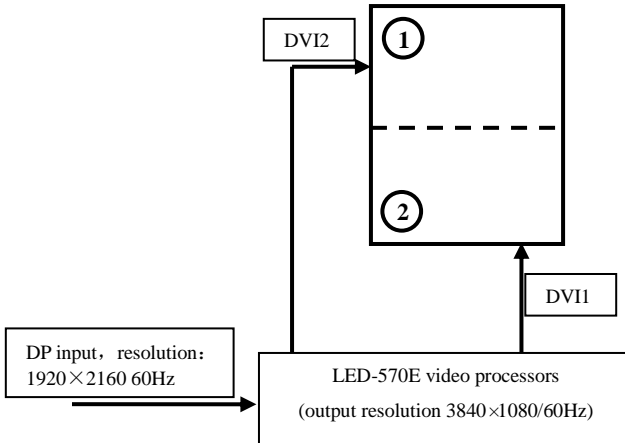

Output resolution: 3840×1080 60Hz.

Use "DP" input function, and set "DP" EDID function to make PC output required resolution : 1920×2160 60Hz.

Turn on the dual image , ch1 and ch2 choose the DP input.

Image 1 mosaic :

Screen H Total	1920
Screen V Total	2160
Screen Width	1920
Screen Height	1080
Screen H Start	0
Screen V Start	1080

Output window and video crop parameter setting :

Output window

Aspect Ratio	Custom
Wight	1920
Height	1080
H Start	0
V Start	0

Dual image

Dual image	On
Wight	1920
Height	1080
H Start	1920
V Start	0
Source Input	DP







Video crop

Image1 Video crop	Off
Image2 Video crop	On
Wight	1920
Height	1080
H Start	1920
V Start	0

# FAQ

LED-570E series processors provide abundant function for the customers, some functions use requires users to have quite a bit of professional knowledge. When you have problems, can try to timing machines, if cannot solve it according the following step, please contact with the local agent, or contact our service department directly. For your safety, do not attempt to repair the product by yourself.

Phenomenon	Check list	Page
No output image and no display on LCD in the front panel.	<ul style="list-style-type: none"> <li>● Check the power cord</li> <li>● Check the power switch</li> </ul>	
LCD in the front panel is displaying information, but no output image or the image is not stable	<ul style="list-style-type: none"> <li>● Check whether properly connected the input signal and have switched to the corresponding source (if no signal, the front panel LCD screen will display no signal, and the machine will have no image output at the moment)</li> <li>● Check display terminals whether to support the output resolution and refresh rate of LED-570E series processors</li> <li>● Check if the brightness and contrast set too low.</li> <li>● Check whether the user color temperature set too low.</li> <li>● Check check image 1 and 2 input status, whether the top picture showed a signal</li> <li>● Try to reset the machine to be the factory setting by "factory reset" of the "function Settings" sub menu.</li> </ul>	<p>[ 16]</p> <p>[ 12]</p> <p>[ 21]</p> <p>[ 21]</p> <p>[ 16]</p> <p>[ 29]</p>
Image display position deviation	<ul style="list-style-type: none"> <li>● Enter "output Settings" submenu, adjust the "horizontal position" and "vertical position", till the image display properly</li> </ul>	[ 22]
VGA or DVI port images showed	<ul style="list-style-type: none"> <li>● Check whether the input signal resolution is accordance with VESA standard.</li> </ul>	[ 11]

abnormal		
VGA Image displayed in un-full screen	<ul style="list-style-type: none"> <li>● Press the front panel "AUTO" button until the image display correct (automatic adjustment, please use the full screen and not take black side signal)</li> </ul>	 16  22
PIP display abnormal	<ul style="list-style-type: none"> <li>● Check if it is reasonable that the item numerical of "horizontal width" and "vertical height" , "horizontal position" and "vertical position" of "PIP" submenu.</li> </ul>	 30
Fade function is invalid	<ul style="list-style-type: none"> <li>● Check whether automatically switch function is closed</li> <li>● Whether the input signal of image 1 and image 2 is valid.</li> </ul>	 25  16
Unable to set resolution for video card	<ul style="list-style-type: none"> <li>● Please set the resolution as your request by "EDID manage" function.</li> </ul>	 29

# Warranty

## The whole unit warranty

---

- One year (from the buying date);
- If the invoice is lost, the 60 days after the production date will be the warranty start date for the product.

## The warranty provisions

---

- The machine soaking and collisions produced besmirch or surface scratches and other abnormal using causes of malfunction or damage;
- Demolition machine or modification, which is not to be agreed by our company;
- Using in the not specified used working conditions, resulting in fault or damage (such as high temperature, low voltage or unstable etc.);
- Force majeure (such as fire, earthquake, etc.) or natural disasters (like lightning, etc) caused the fault or damage;
- Beyond the product warranty.