

NovaPro UHD Jr

All-in-One Controller

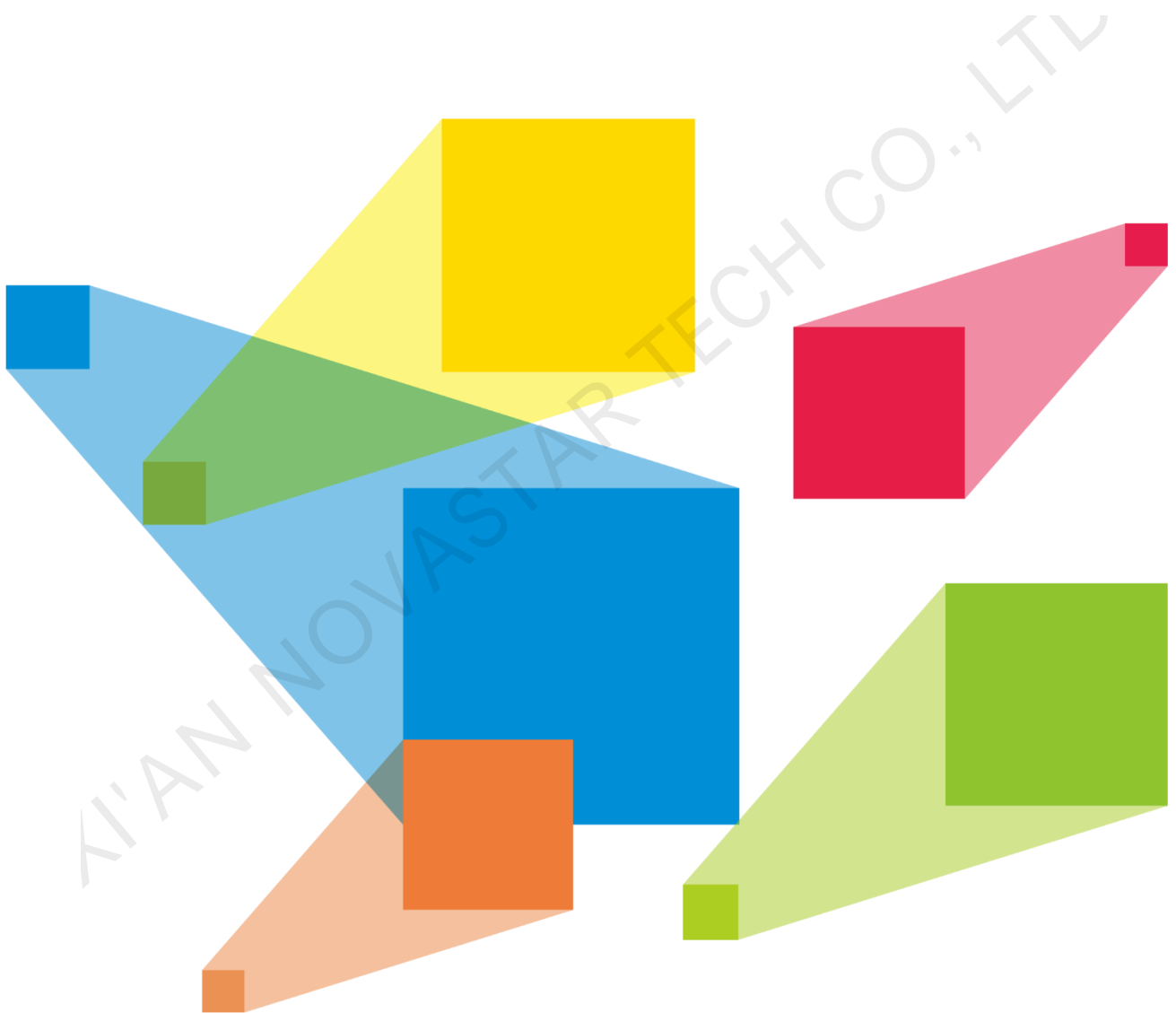

User Manual

Change History

Version	Release Date	Description
V1.2.0	2021-06-01	Changed some components on the rear panel.
V1.1.3	2020-12-31	Optimized the description.
V1.1.2	2019-12-19	Added the description for DVI mosaic backup function.
V1.1.1	2019-10-30	Increased the version number only.
V1.1.0	2019-10-09	<p>New features:</p> <ul style="list-style-type: none"> • Added the third layer (PIP2). • Added the description for optical fiber port and Ethernet port statuses displayed on home screen. • Added the description for 3D function. <p>Changes: HDMI supported HDCP 2.2.</p> <p>Deletes: Deleted the descriptions for Transition Effect and Effect Duration in Display Control.</p>
V1.0.1	2019-07-10	Added the description for HDMI LOOP supporting only 1 level of device cascading.
V1.0.0	2019-06-06	First release

Contents

1 Overview	1
2 Appearance	2
2.1 Front Panel	2
2.2 Rear Panel	3
2.3 Dimensions	5
3 Applications	6
4 Home Screen	7
5 Menu Operations	9
5.1 Screen Brightness	9
5.2 Screen Settings	10
5.2.1 Quick Configuration	10
5.2.2 Advanced Configuration	10
5.2.3 Save to RV Card	11
5.2.4 More Settings	11
5.3 Layer Settings	13
5.3.1 Main Layer and PIP	14
5.3.2 BKG	15
5.4 Input Settings	15
5.4.1 Input Source	15
5.4.2 Setting Input Source Resolution	16
5.4.3 DVI Mosaic	17
5.5 Image Mosaic	19
5.6 Preset Settings	20
5.7 Display Control	20
5.8 Advanced Functions	21
5.8.1 HDR	21
5.8.2 Low Latency	22
5.8.3 OPT Mode	22
5.8.4 3D Mode	23
5.8.5 Self-Test	24
5.9 General Settings	24
5.9.1 Hot Backup	24
5.9.2 Synchronization	24
5.9.3 Fn	24
5.9.4 Output Frame Rate	24
5.9.5 Return to Home	25
5.9.6 Factory Reset	25
5.9.7 About Us	25
5.10 Partial Reset	25
5.11 Communication Settings	25
5.11.1 Communication Mode	25
5.11.2 Network Settings	25
5.12 Working Mode	26
5.13 Language	26
6 Specifications	27
A 3D Function User Manual	28
A.1 For Single NovaPro UHD Jr Unit	28
A.2 For Multiple NovaPro UHD Jr Units	28
A.3 Notes	29

1 Overview

The NovaPro UHD Jr is NovaStar's new all-in-one controller that features excellent video processing capabilities, sending card functions and LED screen configurations. The NovaPro UHD Jr provides a variety of video input connectors, supporting full HD 4Kx2K@60Hz image processing and sending capabilities. Additionally, the NovaPro UHD Jr supports 8Kx1K@60Hz ultra-high resolution settings.

With the help of smart control software V-Can from Novastar, the NovaPro UHD Jr can enable richer image mosaic effects and faster and easier operations.

The NovaPro UHD Jr can send the processed video to the LED screen via Neutrik Ethernet ports and optical fiber ports. Thanks to its powerful video processing capabilities and sending functions, the NovaPro UHD Jr is well suited for stage control systems, conference sites, activities, exhibition sites and other high-end rental applications as well as fine-pitch LED displays.

XI'AN NOVASTAR TECH CO., LTD

2 Appearance

2.1 Front Panel

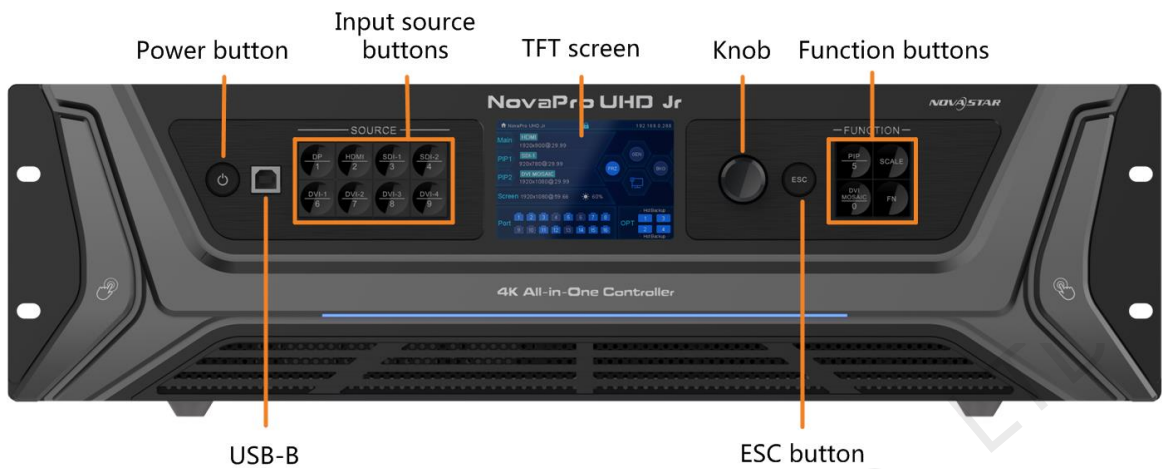

Button	Description
Power button	<ul style="list-style-type: none"> Power on: Press the button to power on the device. Power off: Hold down the button to pop up a dialog box, then rotate the knob to select Yes and press the knob to power off the device.
USB-B	For PC connection for debugging
Input source buttons	<ul style="list-style-type: none"> Input source switching buttons Press the button to switch the input source for the main layer. Button indicators are used to indicate the working status of the input source signal. <ul style="list-style-type: none"> White, always on: Input source is not used, and no input signal is accessed. Fast flashing blue: Input source is used, but no input signal is accessed. Blue, breathing blue: Input source is not used, but input signal is accessed. Blue, always on: Input source is used, and input signal is accessed.
TFT screen	Display the current device status and settings menu.
Knob	<ul style="list-style-type: none"> On the home screen, press the knob to enter the operation menu screen. On the operation menu screen, rotate the knob to select a menu item, and press the knob to confirm the selection or enter the submenu. When a menu item with parameters is selected, you can rotate the knob to adjust the parameters. Please note that after adjustment, you need to press the knob again to confirm the adjustment.
ESC button	Press the button to exit the current menu or cancel the operation.
Function buttons	<ul style="list-style-type: none"> PIP: Enter the layer settings screen. SCALE: Enable/Disable the scaling function of bottom layer. DVI MOSAIC: Switch to DVI mosaic input source. Press it to switch the input source of main layer. FN: This is a custom function button. The function can be customized to Synchronization, Preset Settings, Freeze, Black Out, Quick Configuration, Test Pattern, Image Quality and Main Layer. It is Synchronization by default.

2.2 Rear Panel

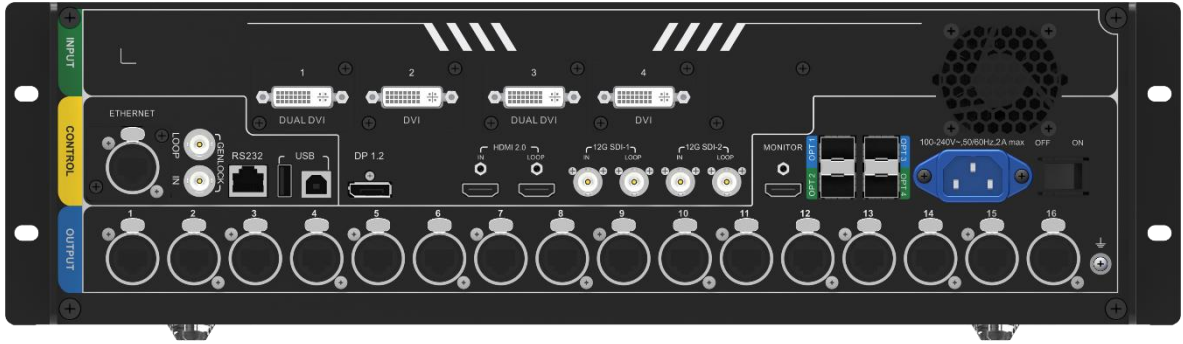

Input		
Connector	Quantity	Description
DVI	4	<ul style="list-style-type: none"> Four DVIs are all single-link DVI connectors by default. 4x DVI inputs Each DVI: Input resolution up to 2048x1152@60Hz, downward compatible 4 DVI input sources constitute 1 input source (DVI MOSAIC). Max. width: 3840 pixels. Max. height: 3840 pixels In dual-link mode. DVI 1 and DVI 3 are dual-link DVI connectors while DVI 2 and DVI 4 are unavailable. DVI 1/DVI 3: Input resolution up to 3840x1080@60Hz, downward compatible. 2 DVI input sources constitute 1 input source (DVI MOSAIC). Max. width: 3840 pixels. Max. height: 3840 pixels Supports input resolution settings. HDCP 1.4 compliant Does not support interlaced signal inputs.
12G-SDI	2	<ul style="list-style-type: none"> Supports ST-2082-1 (12G), ST-2081-1 (6G), ST-424 (3G) and ST-292 (HD) standard video inputs. Input resolution up to 4096x2160@60Hz, downward compatible Supports interlaced signal inputs. Does not support input resolution and bit depth settings. Maximum resolution supported: Max. width: 8192 pixels. Max. height: 8192 pixels
DP 1.2	1	<ul style="list-style-type: none"> Input resolution up to 3840x2160@60Hz, downward compatible HDCP 1.3 compliant Supports input resolution settings. Maximum resolution supported: Max. width: 8192 pixels. Max. height: 8192 pixels Does not support interlaced signal inputs.
HDMI 2.0	1	<ul style="list-style-type: none"> Input resolution up to 3840x2160 @60Hz, downward compatible HDCP 2.2 compliant Supports input resolution settings.

		<ul style="list-style-type: none"> Maximum resolution supported: Max. width: 8192 pixels. Max. height: 8192 pixels Does not support interlaced signal inputs.
Output		
Connector	Quantity	Description
Ethernet port	16	<ul style="list-style-type: none"> 16x Neutrik Gigabit Ethernet output connectors, allowing for a loading capacity of up to 10,400,000 pixels. Maximum loading capacity: Max. width: 16384 pixels, max. height: 8192 pixels Maximum loading capacity of a single Ethernet port: 8-bit input source: 650,000 pixels. 10-bit/12-bit input source: 320,000 pixels.
OPT 1–4	4	<ul style="list-style-type: none"> 10G optical connectors Copy and hot backup modes are available when four OPT ports are all used for output. OPT 1 transmits data of Ethernet ports 1–8. OPT 2 transmits data of Ethernet ports 9–16. OPT 3 serves as the copy/hot backup for OPT 1. OPT 4 serves as the copy/hot backup for OPT 2.
HDMI 2.0 LOOP	1	<ul style="list-style-type: none"> HDMI loop output Only 1 level of device cascading supported HDCP 2.2 compliant EDID management supported
12G-SDI LOOP	2	SDI loop output
MONITOR	1	<ul style="list-style-type: none"> An HDMI connector dedicated for output monitoring Resolution up to 1920x1080@60Hz
Control		
Connector	Quantity	Description
ETHERNET	1	Connect to the PC for communication, or connect to the Web for device control.
USB (Type-B)	1	<ul style="list-style-type: none"> Connect to the PC for device control. Used as the input connector to connect a NovaPro UHD Jr unit for image mosaic
USB (Type-A)	1	Used as the output connector to connect a NovaPro UHD Jr unit for image mosaic
GENLOCK IN-LOOP	1	Connect to a synchronization signal to synchronize all the connected NovaPro UHD Jr units.
RS232	1	Connect to the central control device.

2.3 Dimensions

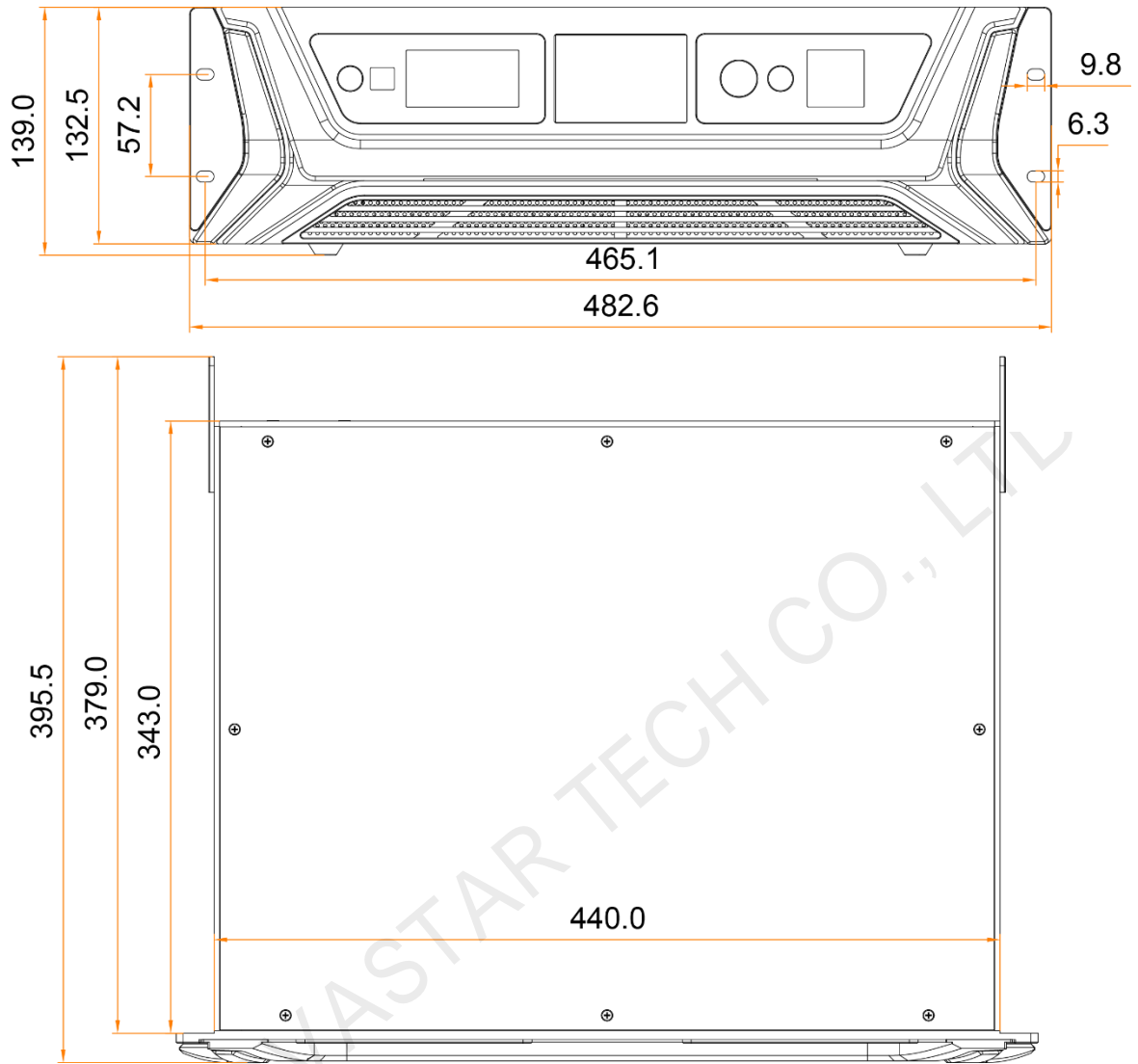

Tolerance: ± 0.3 Unit: mm

3 Applications

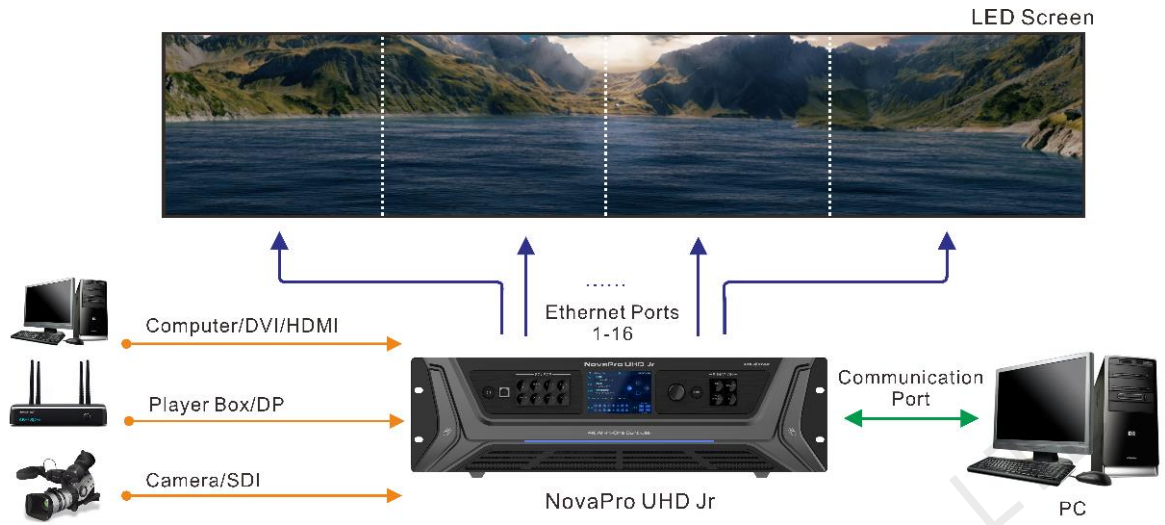

XI'AN NOVASTAR TECH CO.,LTD

4 Home Screen

Figure 4-1 Home screen

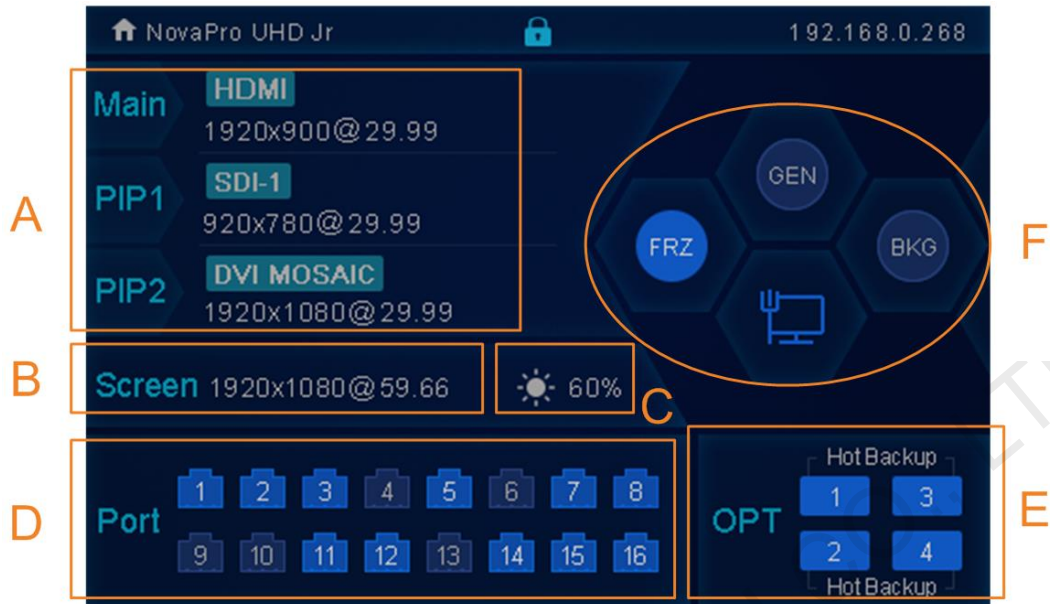











Table 4-1 Home screen descriptions

Area	Icon	Description
A		Denotes the layer is active and displays the layer input source name and resolution.
		Denotes the layer is inactive.
B		Displays the resolution and frame rate of the configured screen.
C		Displays the screen brightness.
D		The device is in video controller mode and this Ethernet port is connected.
		This Ethernet port is not connected.
		This Ethernet port is connected and serves as the output backup port.
E		The OPT mode is set to Hot Backup, optical fiber ports 3/4 backup the data of optical fiber ports 1/2.
		The OPT mode is set to Copy, optical fiber ports 3/4 copy the data of optical fiber ports 1/2.
F		The synchronization function is turned on, and synchronization succeeded.
		The synchronization function is turned off.
		The synchronization function is turned on, and synchronization is being performed.

			The synchronization function is turned on, but synchronization failed.
Display control			The LED screen displays the black screen.
			The LED screen displays the selected test pattern.
			The LED screen displays the current input source normally.
			The output image is frozen.
BKG			The BKG function is turned on.
			The BKG function is turned off.
Communication			The current device communication mode is USB Preferred.
			The current device communication mode is LAN Preferred.
			The current device is not connected to the control PC.

Ethernet Port Statuses

Rotate the knob clockwise on the home screen to display the optical fiber port working statuses as shown in the below figure.

Figure 4-2 Optical fiber port statuses – Copy



Figure 4-3 Optical fiber port statuses – Hot backup

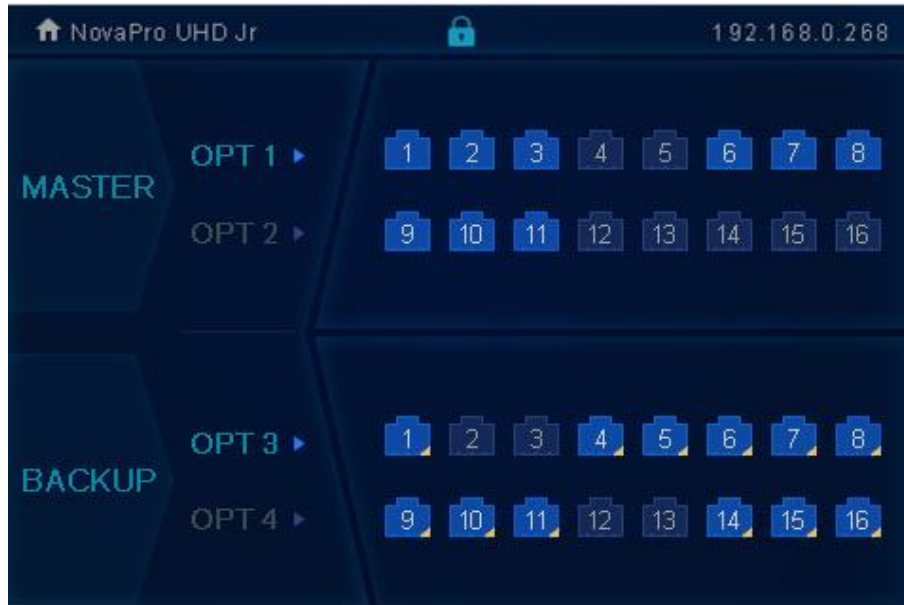

5 Menu Operations

Button descriptions:

Knob

On the home screen, pressing the knob enters the operation menu screen.

On the operation menu screen, rotate the knob to select a menu item, and press the knob to confirm the selection or enter the submenu.

When a menu item with parameters is selected, you can rotate the knob to adjust the parameters. Please note that after adjustment, you need to press the knob again to confirm the adjustment.

ESC: Press the button to exit the current menu or cancel the operation.

5.1 Screen Brightness

You can adjust the screen brightness in an eye-friendly way according to the current ambient brightness. Besides, appropriate adjustment of screen brightness can extend the service life of the LED screen.

Figure 5-1 Screen brightness

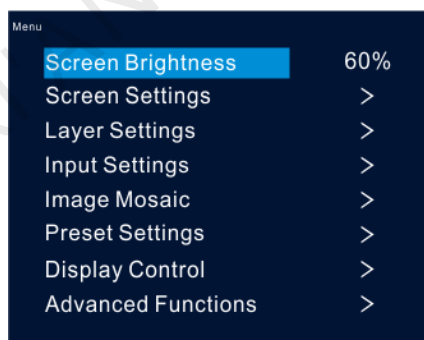

Step 1 Press the knob to enter the device menu.

Step 2 Select **Screen Brightness** and press the knob to confirm the selection.

Step 3 Rotate the knob to adjust the brightness value, and the LED screen will display the effect in real-time. Then press the knob to apply the set brightness when you are satisfied with it.

5.2 Screen Settings

You can configure the screen to make it display the whole image correctly.
The options are **Quick Configuration** and **Advance Configuration**.

5.2.1 Quick Configuration

Preconditions

- LED screen must be a regular screen.
- Cabinets of the screen must be regular cabinets with the same resolution.
- The following data flow settings are supported. During data flow settings, you must ensure that the physical connection of each port is along the same direction and downward to next one.

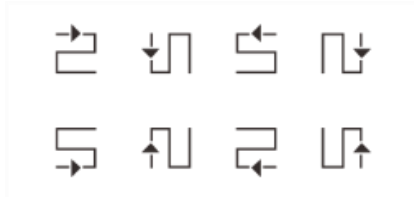

- During data flow settings, you must ensure that the Ethernet Port 1 is at the beginning position of the whole physical connection.

Procedure

Step 1 Power on the LED screen.

Step 2 Rotate the knob to choose **Screen Settings** > **Quick Configuration**, and press it to enter its submenu.

Figure 5-2 Quick configuration

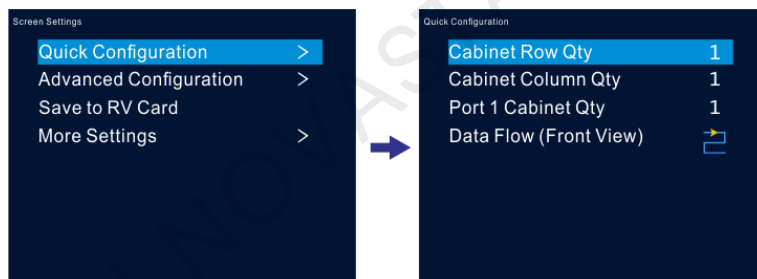

Step 3 Set **Cabinet Row Qty** and **Cabinet Column Qty** according to the actual row and column quantities of the cabinets.

Step 4 Rotate the knob to **Port 1 Cabinet Qty** to set the quantity of the cabinets loaded by Ethernet port 1.

Step 5 Rotate the knob to **Data Flow (Front View)** and press it, then select an appropriate physical connection mode of the cabinets.

During data flow settings, you can view the real-time effects of different data flow settings on LED display by rotating the knob. When you are satisfied with the LED display image, press the knob to save the settings; when you are not satisfied, press **ESC** button to exit the current operation and the settings will not be saved.

5.2.2 Advanced Configuration

You can set the cabinet row and column quantities, horizontal offset, vertical offset and data flow of the cabinets loaded by a single Ethernet port.

Procedure

Step 1 Press the knob to enter the device menu.

- Step 2 Rotate the knob to choose **Screen Settings > Advanced Configuration**, and press it to enter its submenu.
- Step 3 Turn on the advanced configuration function, and then set the cabinet row and column quantities, horizontal offset, vertical offset and data flow for the target Ethernet port.

Figure 5-3 Advanced configuration

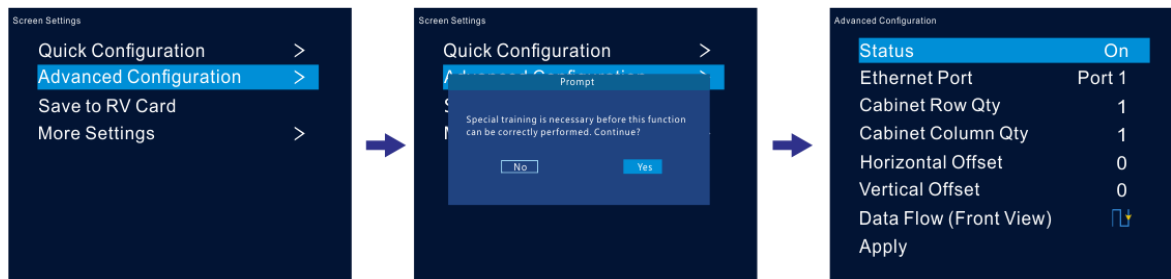

5.2.3 Save to RV Card

You can send and save the screen configuration to the receiving card. The configuration data will not be lost after the device is powered off.

5.2.4 More Settings

- Step 1 Press the knob to enter the device menu.
- Step 2 Rotate the knob to choose **Screen Settings > More Settings**, and press it to enter its submenu.

Mapping

You can turn on this function to display the sequence numbers of Ethernet ports and cabinets.

Figure 5-4 Mapping



Example: "P:05" stands for the Ethernet port number and "#001" stands for the cabinet number.

Note:

The receiving card employed by the system must support the Mapping function.

Load RCFGx Files

After the LED screen is powered on, if a certain cabinet or the entire LED screen is not lit, you can load the receiving card configuration files (namely RCFGx files) that have been configured on NovaLCT software to the NovaPro UHD Jr.

- Step 1 (Optional) After you have configured the screen on NovaLCT, click **Save to File** under the **Receiving Card** tab to save the configuration file to PC.

Figure 5-5 Save receiving card configuration file

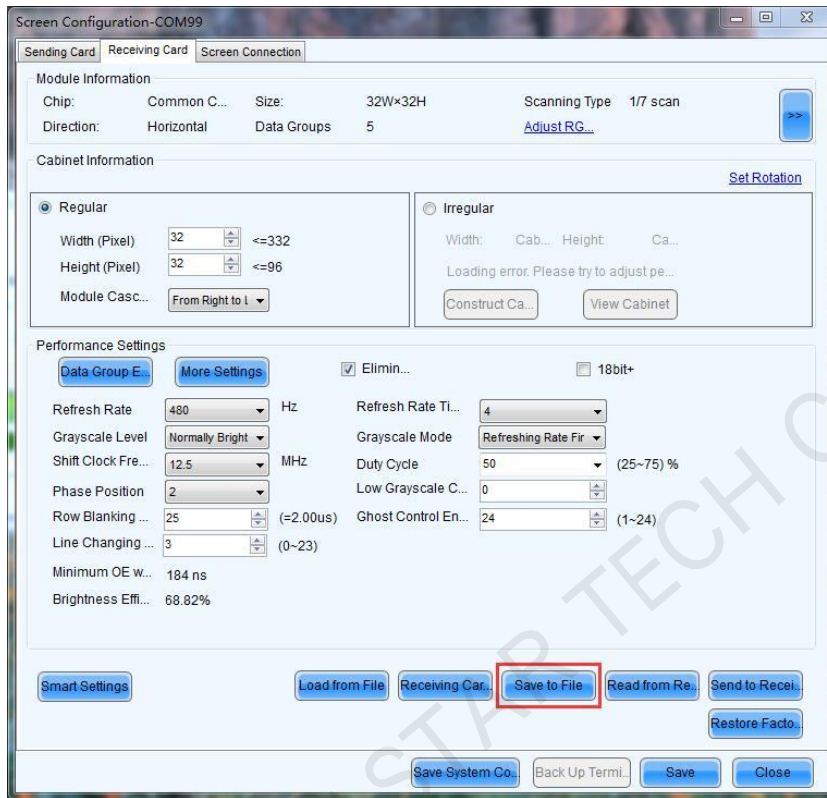

- Step 2 Choose **Tools > Controller Cabinet Configuration File Import** to enter the controller cabinet configuration file importing page.

Figure 5-6 Importing controller cabinet configuration file

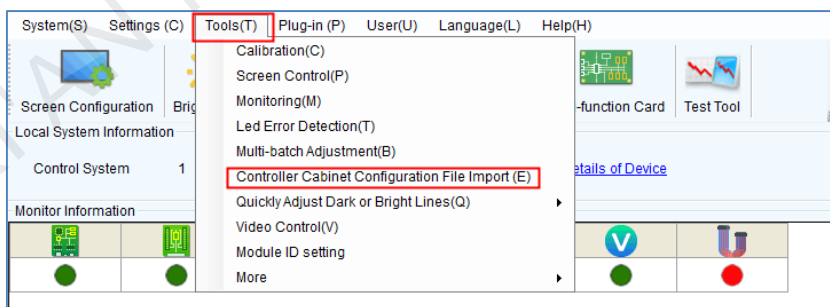

- Step 3 Click **Add Configuration File** to select the target file (*.rcfgx/*.rcfg) from your PC, and then click **Open**.

- Step 4 Click **Save the Change to HW** to save the configuration file to the NovaPro UHD Jr.

Figure 5-7 Saving configuration file to NovaPro UHD Jr

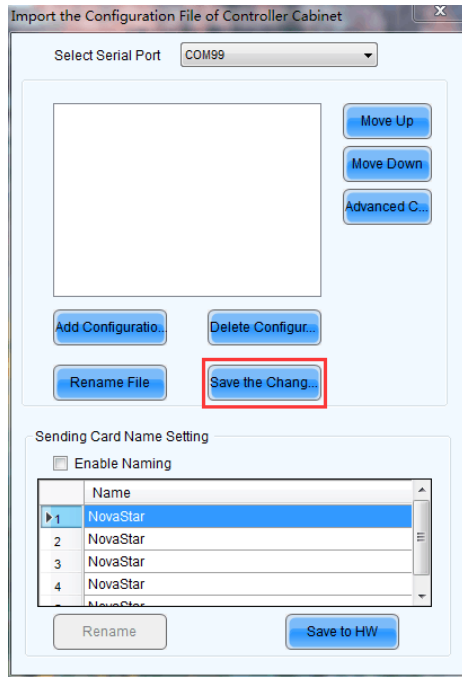

Note:

The configuration file for irregular cabinet is not supported.

LED Screen Color

You can adjust the screen color and the LED screen will display the effect in real-time.

Table 5-1 Screen color parameters

Parameter	Description
Color temperature	You can set the color to Standard , Cool , Warm and Custom . Custom allows you to adjust individual R, G or B value.
Gamma	The range is 1.0–4.0 and the stepping is 0.1.

Figure 5-8 Color temperature effect



5.3 Layer Settings

Step 1 Press the knob to enter the device menu.

Step 2 Rotate the knob to select **Layer Settings** and press the knob to enter the layer settings screen where you can set the followings.

- Main layer
- PIP1 and PIP 2
- BKG

5.3.1 Main Layer and PIP

Menu	Description
Status	The status of the selected layer: On and Off Note: Press the PIP button in FUNCTION area on the device front panel to enter the layer settings screen.
Input Source	The input source of the layer Note: Press the input source button in SOURCE area on the device front panel to select the input source for the main layer.
Scaling Mode	The options are Full Screen, Pixel to Pixel and Custom.
H Width	The horizontal width of the layer The range is -32768~32768.
V Height	The vertical height of the layer The range is -32768~32768.
Initial X	The initial horizontal coordinate of the layer
Initial Y	The initial vertical coordinate of the layer
Input Crop	The function of cropping the input source image and displaying it in full screen Status: You can turn on or turn off this function for the selected layer. H Width: The horizontal width of the current input source. If no input source is detected, the default value is 1920. V Height: The vertical height of the current input source. If no input source is detected, the default value is 1080. Initial X: The horizontal initial coordinate of the cropped part upon the current input source. The range is 0–horizontal width of input source and the default value is 0. Initial Y: The vertical initial coordinate of the cropped part upon the current input source. The range is 0–vertical height of input source and the default value is 0.
Priority	The layer priority. The options are 1 , 2 and 3 . 1: Send the layer to the back. 2: Place the layer in the middle. 3: Bring to the layer to the front.
Reset	Reset all the layer parameters to default settings.

Figure 5-9 Layer parameter descriptions

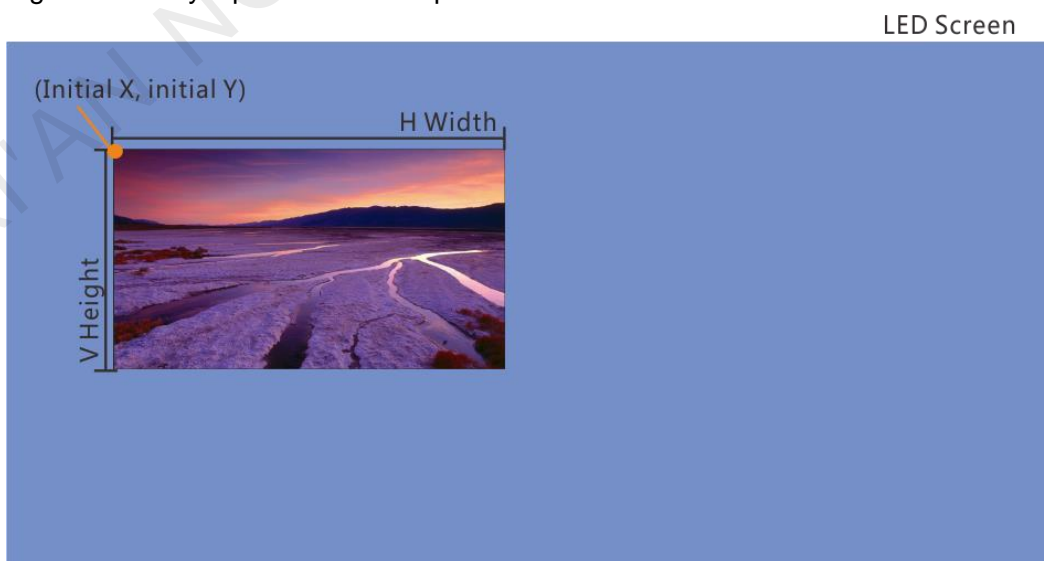
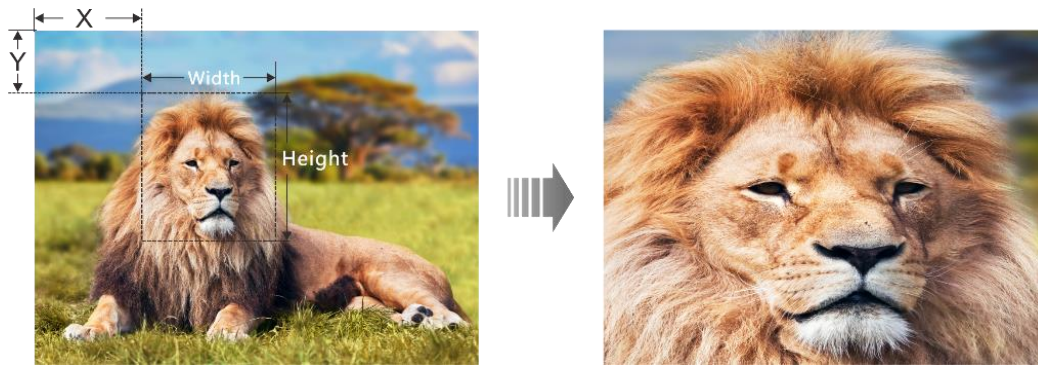

Figure 5-10 Input crop



5.3.2 BKG

You can set the background for the displayed image. The BKG is located at the back.

Menu	Description
Status	The status of the BKG: On and Off (default)
Type	The options area Pure Color and Image .
Pure Color BKG	You can adjust the individual R, G or B value to set a pure color BKG.
Capture	<p>Source: Select an input source.</p> <p>Save To: Set the save location of the captured image. The options include BKG 1 / BKG 2 / BKG 3 / BKG 4.</p> <p>Apply: Save the captured image to the selected save location. At most 4 BKG images are supported.</p>

Figure 5-11 Capturing input source image
Input Source



5.4 Input Settings

5.4.1 Input Source

The NovaPro UHD Jr supports DP, HDMI, SDI-1, SDI-2 and DVI input connectors.

Rotate the knob to select the desired input source and press the knob to enter the input source resolution menu.

Figure 5-12 Selecting input source

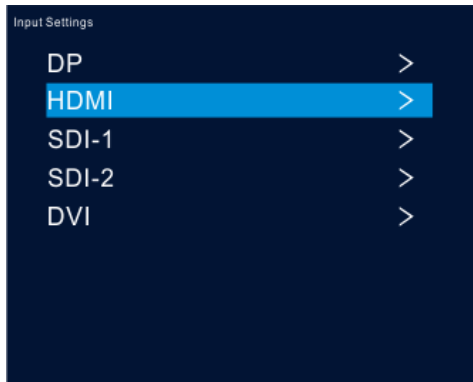

5.4.2 Setting Input Source Resolution

You can adjust the resolution and frame rate of the input source through the following two ways.

- Standard resolution
- Custom resolution

Figure 5-13 Setting input source resolution

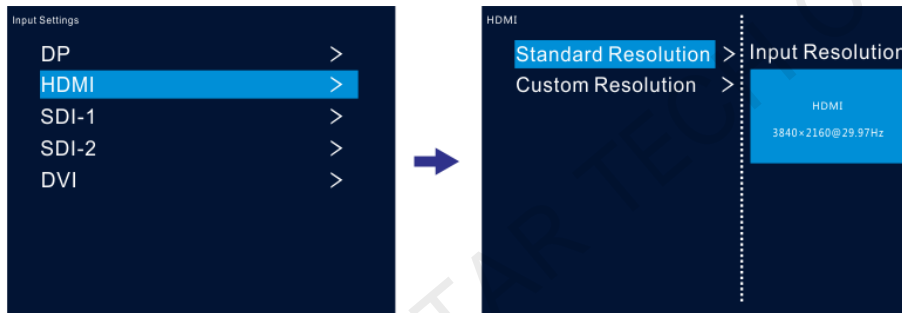

Note:

SDI input source does not support resolution settings.

Standard Resolution

You can select a standard resolution and frame rate. Then rotate the knob to select **Apply** and press the knob to make the settings take effect.

Figure 5-14 Standard resolution

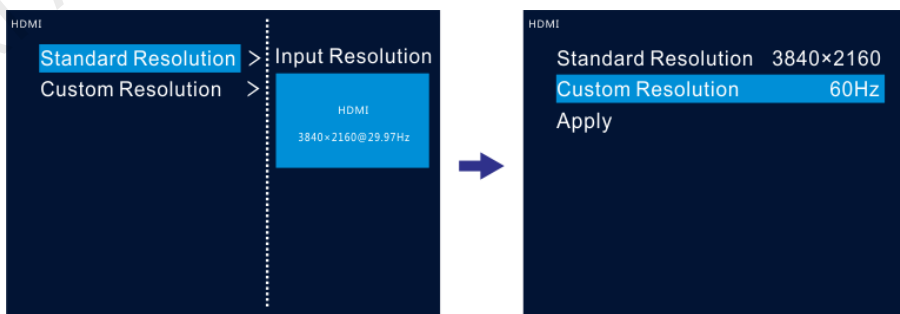

Table 5-2 Standard connector resolutions

Standard resolutions	DP 1.2	HDMI 2.0	Dual-DVI	Single-DVI
1024x768@ (48/50/59.94/60/75/85) Hz	√	√	√	√

Standard resolutions	DP 1.2	HDMI 2.0	Dual-DVI	Single-DVI
1280x720@ (23.98/24/25/29.97/30/48/50/59.94/60) Hz	√	√	√	√
1280x1024@ (48/50/59.94/60/75/85) Hz	√	√	√	√
1364x768@ (50/59.94/60) Hz	✘	√	✘	✘
1366x768@ (50/59.94/60) Hz	√	✘	√	√
1440x900@ (60/75/85) Hz	√	√	√	√
1600x1200@ (48/50/59.94/60) Hz	√	√	√	√
1680x1050@60Hz	√	√	√	√
1920x1080@ (23.98/24/25/29.97/30/48/50/59.94/60) Hz	√	√	√	√
1920x1200@ (50/59.94/60) Hz	√	√	√	√
2048x1080@ (30/48/50/59.94/60) Hz	√	√	√	√
2048x1152@ (30/60) Hz	√	√	√	√
2560x1080@ (50/59.94/60) Hz	√	√	√	✘
2560x1600@ (50/59.94/60) Hz	√	√	√	✘
2560x1600@120Hz	√	√	✘	✘
3840x1080@30Hz	√	√	√	√
3840x1080@ (50/59.94/60) Hz	√	√	√	✘
3840x1080@120Hz	√	√	✘	✘
3840x2160@ (23.98/24/25/29.97/30) Hz	√	√	√	✘
3840x2160@ (50/59.94/60) Hz	√	√	✘	✘

Custom Resolution

Rotate the knob to set a custom width, height and frame rate. Then rotate the knob to select **Apply** and press the knob to make the settings take effect. If you do not press the knob, the settings will not take effect.

Figure 5-15 Custom resolution

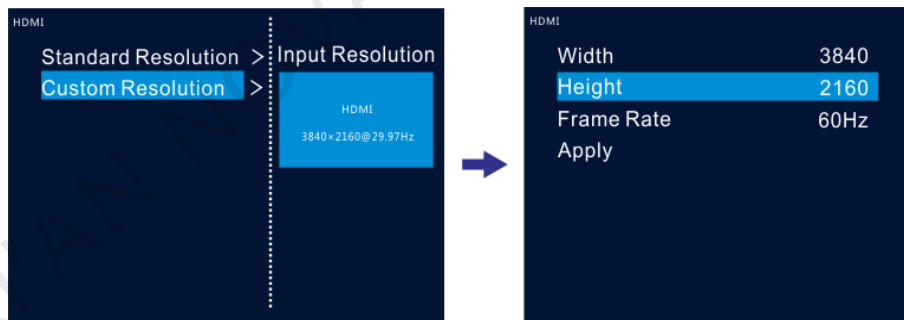

5.4.3 DVI Mosaic

- Step 1 Rotate the knob to choose **Input Settings > DVI**.
- Step 2 Rotate the knob to set the DVI input mode to **Single Link** or **Dual Link**. The connector working mode is shown in below.

Figure 5-16 Single link mode

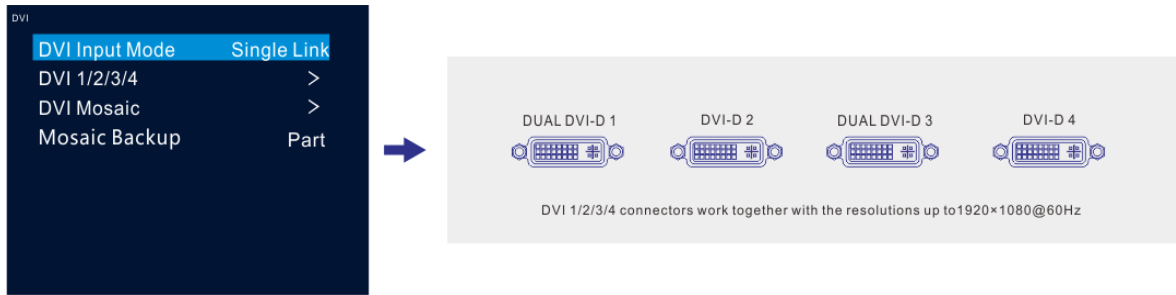
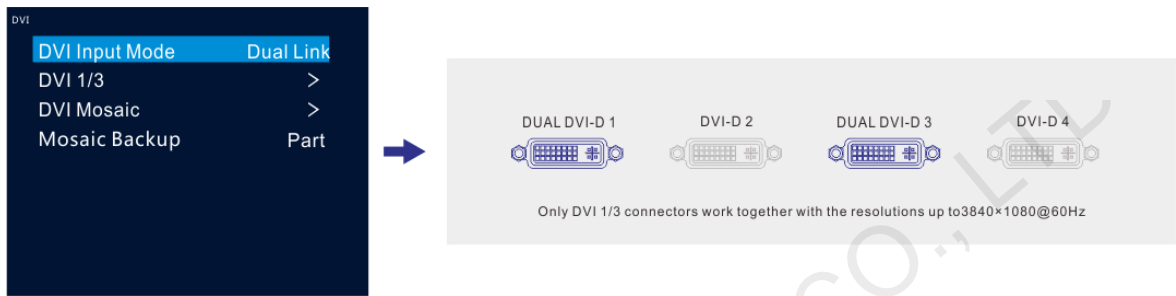



Figure 5-17 Dual link mode



Step 3 In single link mode, the resolutions of DVI 1, 2, 3 and 4 are adjusted together. In dual link mode, the resolutions of DVI 1 and 3 are adjusted together. For resolution adjustment, please refer to [5.4.2 Setting Input Source Resolution](#).

Step 4 Rotate the knob to select **DVI Mosaic** and press the knob to enter the DVI mosaic settings menu.

Menu	Description
Layout	Set the mosaic layout for 4 DVI connectors. Single link mode supports 7 layouts:  , Dual link mode supports 2 layouts:  .
Width	Adjust the width of the individual mosaic area. Single link: The default width is 1920 and the range is 64–3840. Dual link: The default width is 3840 and the range is 64–3840.
Height	Adjust the height of the individual mosaic area. Single link: The default width is 1080 and the range is 64–3840. Dual link: The default width is 1080 and the range is 64–3840.
Apply	Make the settings take effect.

Step 5 Rotate the knob to set the Mosaic backup mode.

- Part: When one or multiple DVI sources in the DVI mosaic group are abnormal, these sources are not displayed and other DVI sources are displayed normally.
- Group: When one or multiple DVI sources in the DVI mosaic group are abnormal, the backup device will replace the primary device to output the image.

Note:

Only one interlaced SDI input is supported in DVI mosaic mode of four connectors.

Mosaic Backup is set to **Part** by default. In device backup mode, please set **Mosaic Backup** to **Group** for both the primary and backup devices to ensure the output image can be displayed normally.

5.5 Image Mosaic

When the pixel count of the LED screen is larger than the loading capacity of a single NovaPro UHD Jr unit, the image mosaic function is required. The total loading capacity of all cascaded NovaPro UHD Jr units equals to the total pixel count of the LED screen.

Figure 5-18 Image mosaic parameters

Image Mosaic	
Status	On
Total H Pixels	7680
Total V Pixels	4320
Load Area Width	3840
Load Area Height	2160
Load Area Initial X	0
Load Area Initial Y	0

Example: If the pixel count of the LED screen is 7680x4320 which exceeds the loading capacity of a single NovaPro UHD Jr unit, 4 NovaPro UHD Jr units are used together for image mosaic. The connections are shown in the below figure.

Figure 5-19 Connections

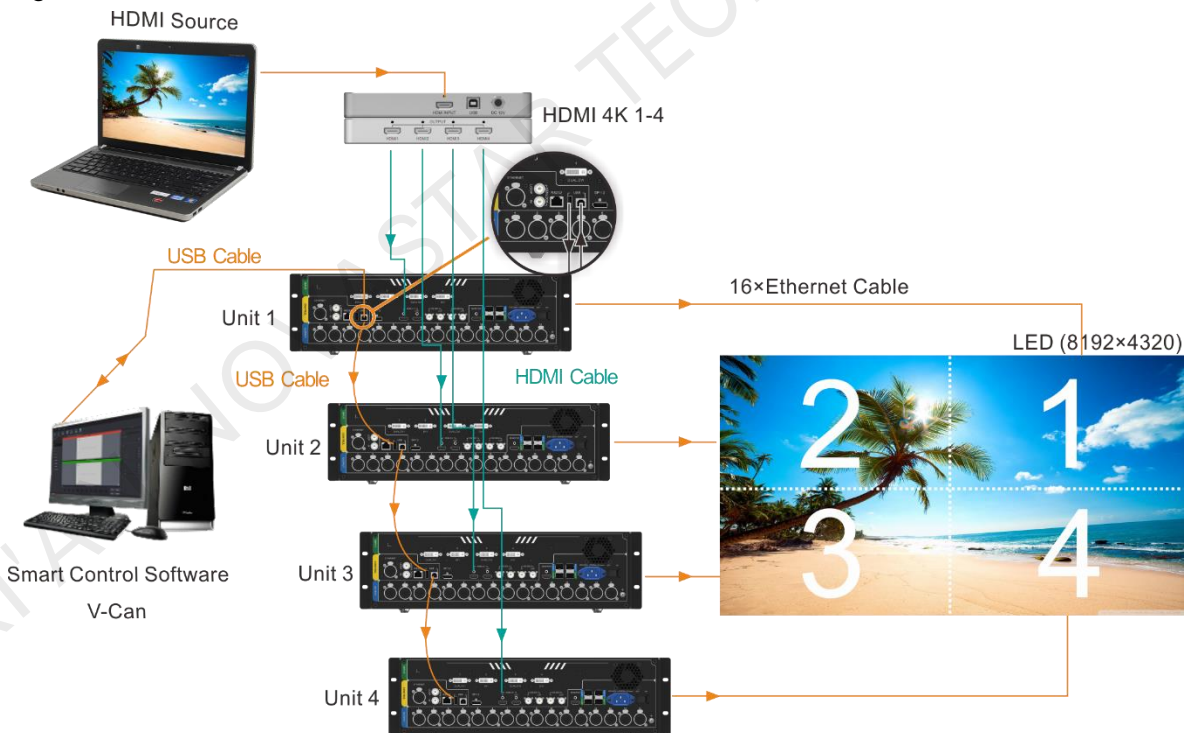

Table 5-3 Parameter settings

Device No.	Load Area Width	Load Area Height	Load Area Initial X	Load Area Initial Y
1	3840	2160	3840	0
2	3840	2160	0	0
3	3840	2160	0	2160
4	3840	2160	3840	2160

5.6 Preset Settings

The NovaPro UHD Jr supports 10 user presets. User can save, load and clear the configured presets.

Step 1 Rotate the knob to select **Preset Settings** and press the knob to enter the submenu.

Step 2 Rotate the knob to select the desired preset and press the knob to pop up a dialog box. In the box, four preset operations are provided: **Save**, **Load**, **Clear** or **Copy To**.

Figure 5-20 Preset operations

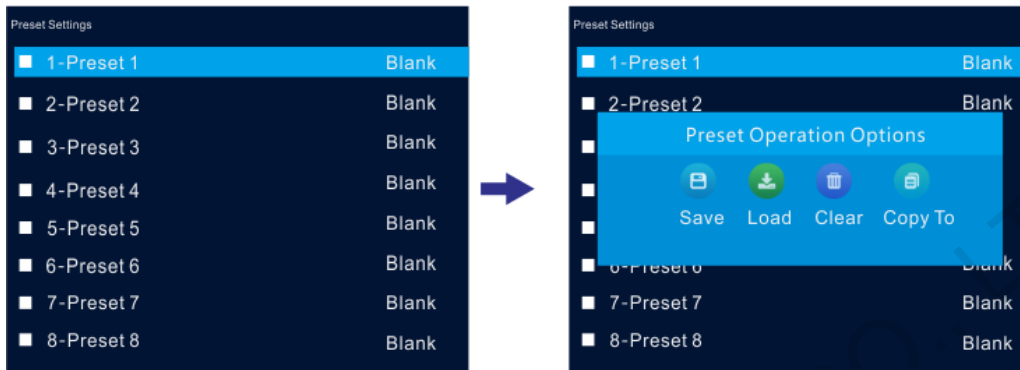

- **Save:** Save the current layer layout and settings to the target preset.
- **Load:** Load the selected preset to current lay layout.
- **Clear:** Clear all the contents in the selected preset.
- **Copy To:** Copy the current preset to the target preset.

Note:

If the target preset has data, **Copy To** operation will overwrite the existing data in the preset.

You can also press the number button on the front panel to quickly load a preset. For example, press the button 1 to load 1-Preset 1 and press the button 2 to load 2-Preset 2, and so on.

5.7 Display Control

This function is used to control the display. You can set the display to go black, freeze the display, display a test pattern, or go to normal display.

Step 1 Press the knob to enter the device menu.

Step 2 Rotate the knob to select **Display Control** and press the knob to enter the display control screen where you can set the followings.

- **Normal:** Display the content of current input source normally.
- **Freeze:** Freeze the current frame of the output image.
- **Black Out:** Make the screen go black.
- **Test Pattern:** Test the display effect and working status of the LED screen. Test patterns include **Pure Color**, **Gradient**, **Grid**, **Brightness**, **Spacing** and **Speed**.
- **Image Color:** Adjust the color of the output image and the LED screen will display the effect in real-time.

Table 5-4 Image color parameters

Menu	Description
Brightness	The range is 0–100 and the stepping is 1.
Contrast	The range is 0–100 and the stepping is 1.
Saturation	The range is 0–100 and the stepping is 1.

Hue	The range is -180–180 and the stepping is 1.
-----	--

5.8 Advanced Functions

Advanced functions include HDR, low latency, OPT mode, 3D mode and self-test settings.

5.8.1 HDR

HDR is the abbreviation for High-Dynamic Range. HDR function can greatly enhance the display image quality, allowing for a more clear and vivid image when the device is used together with NovaStar A8s/A10s receiving cards.

Figure 5-21 System architecture

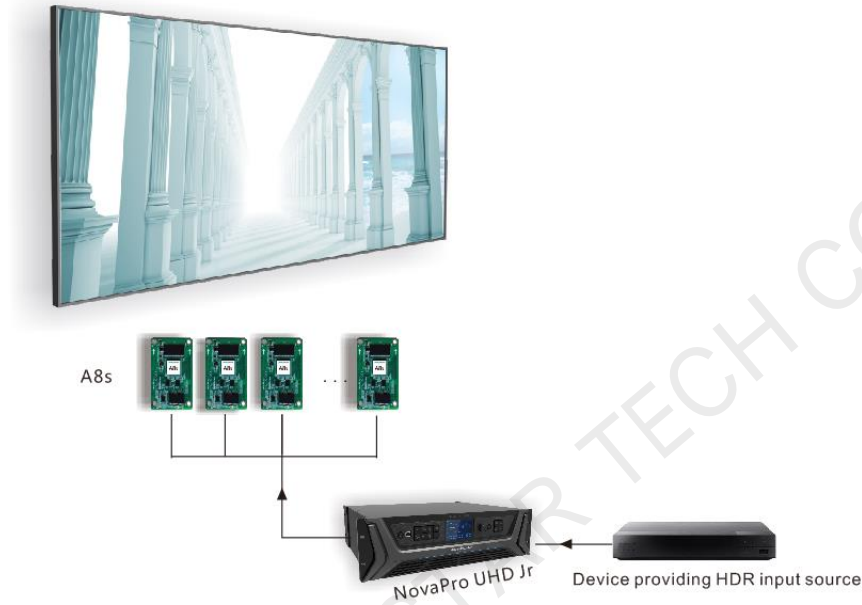

Figure 5-22 HDR effect



- Step 1 Choose **Advanced Functions** > **HDR** > **Status** to enable the HDR function.
- Step 2 Rotate the knob to adjust the value of each parameter to improve the image quality.

Menu	Description
Peak Screen Brightness	Adjust the screen brightness under normal operation. The range is 100–1000 and the default setting is 1000 .
Ambient Brightness	Display the ambient brightness. The range is 0–200 and the default setting is 30 .
Low Grayscale Mode	The range is 0–50 and the default setting is 15 .

- Step 3 (Optional) Select **Reset** to reset all the parameters to default values.

Note:

Only HDR10 input source is supported.

When HDR function is enabled, the output loading capacity will be reduced by 50%.

5.8.2 Low Latency

Low latency reduces the input source signal latency from input to output image of the NovaPro UHD Jr. This function can realize 2 frame delay from sending card to receiving card when the device is used together with NovaStar Armor series receiving cards.

Note:

The loading width of a single Ethernet port should be no greater than 512 pixels when low latency function is used.

The supported Armor series receiving cards include A8, A8s, A9s and A10s.

5.8.3 OPT Mode

The NovaPro UHD Jr supports two OPT modes: **Hot Backup** (default) and **Copy**.

- Hot Backup: Optical fiber ports 3/4 backup the data of optical fiber ports 1/2.
- Copy: Optical fiber ports 3/4 copy the data of optical fiber ports 1/2.

Hot Backup

Step 1 Perform the hardware connections for hot backup mode.

Figure 5-23 Connections for hot backup mode

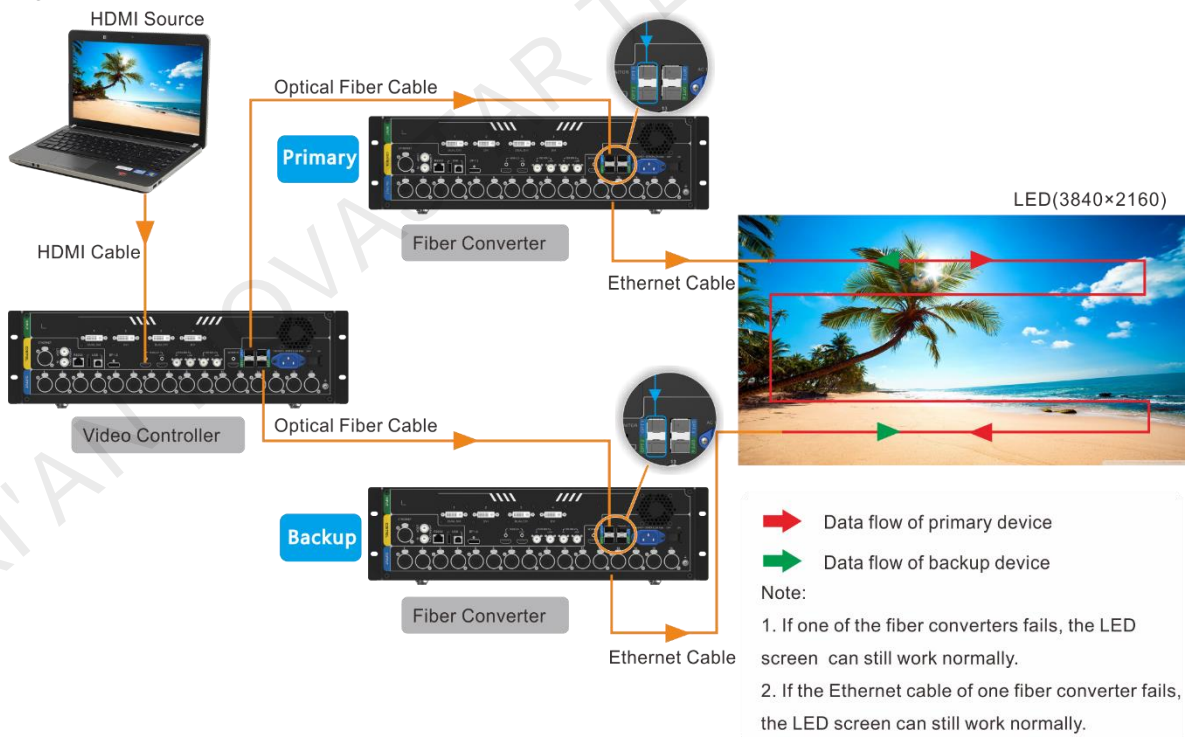

Step 2 Choose **Advanced Functions > OPT Mode > Hot Backup** to set the OPT mode as hot backup.

Copy

Step 1 Perform the hardware connections for copy mode.

Figure 5-24 Connections for copy mode

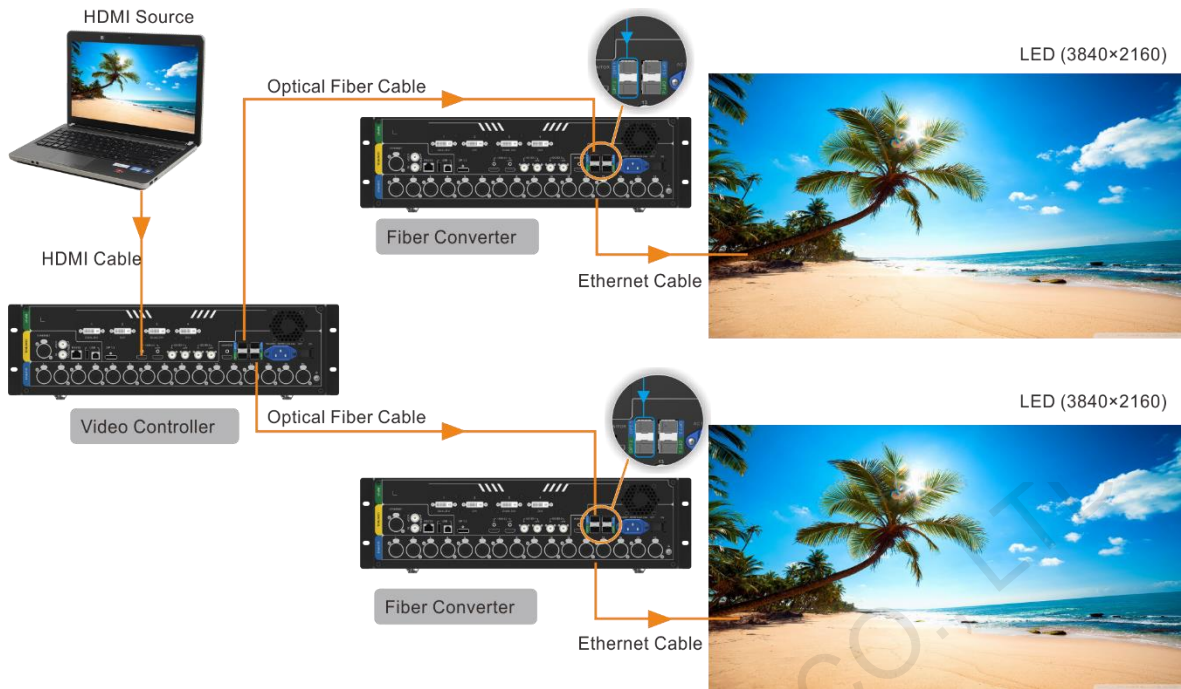

Step 2 Choose **Advanced Functions** > **OPT Mode** > **Copy** to set the OPT mode as copy.

5.8.4 3D Mode

The NovaPro UHD Jr can work with the EMT200 3D transmitter and 3D glasses to provide you with 3D visual experience. For details, please see [A 3D Function User Manual](#).

Note:

Turning on 3D mode will halve the device output capacity.

Figure 5-25 Hardware connections

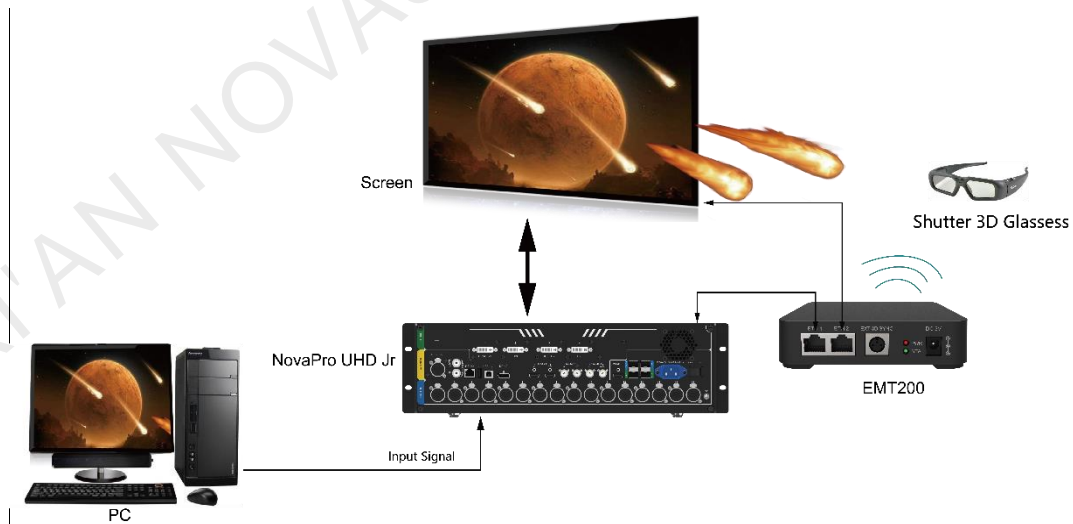

Step 1 Perform the hardware connections as shown in [Figure 5-25](#).

Step 2 Choose **Advanced Functions** > **3D Mode** > **Status** to turn on the function.

Step 3 Select the 3D format. The options are **Side-by-Side**, **Top-and-Bottom** and **Frame Sequential**.

Step 4 Set the eye priority according to the 3D glasses mode. The options are **Left** and **Right**.

Step 5 Select **More Settings** to set the following items.

- Right Eye Start
- Signal Delay Time (us)
- Third-Party Transmitter

5.8.5 Self-Test

You can test the device by yourself when the device fails, then feedback the result to NovaStar.

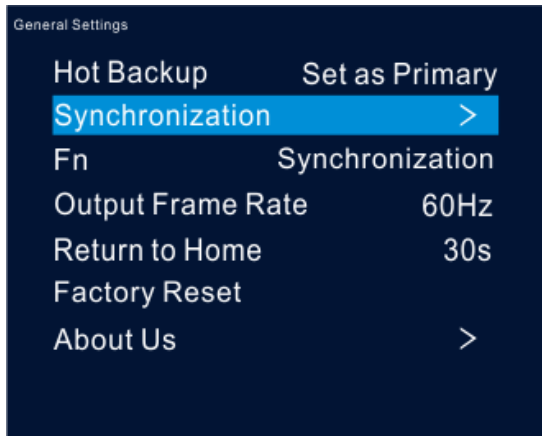

5.9 General Settings

Figure 5-26 General settings



5.9.1 Hot Backup

The NovaPro UHD Jr supports two hot backup modes: **Set as Primary** and **Set as Backup**. Figure 5-23 shows the application for this function.

- Set as Primary: The target Ethernet port on the home screen is highlighted. For example, .
- Set as Backup: The target Ethernet port on the home screen is highlighted and displayed with a small triangle icon at the bottom right. For example, .

When the primary device fails, the backup device will take over the work in real time.

5.9.2 Synchronization

You can select a synchronization signal to synchronize the cascaded devices.

Step 1 Rotate the knob to select **Synchronization** and press the knob to enter the submenu.

Step 2 Rotate the knob to set the synchronization status and source respectively.

- Status: Turn on or turn off this function. It is off by default.
- Source: Select the target input source.

Note:

When the input source resolution is changed or the input source cable is replugged, you need to re-set the function. Please turn off the function and turn it on again.

5.9.3 Fn

The **Fn** button on the device front panel can be customized to a **Synchronization**, **Preset Settings**, **Freeze**, **Black Out**, **Test Pattern**, **Quick Configuration**, **Image Color** or **Main Layer** shortcut button.

5.9.4 Output Frame Rate

You can set the output frame rate of the image output by Ethernet port. The range is 23.98 Hz–120 Hz and the default setting is 60 Hz.

5.9.5 Return to Home

You can set the period of time during which the system stays at the current page before returning to the homepage automatically when there is no operation performed. The default setting is 60s and the maximum value is 3600s.

5.9.6 Factory Reset

You can reset all user data on the device to factory settings.

5.9.7 About Us

You can view the following information.

- Device hardware version
- Company website (www.novastar.tech)
- Email address (support@novastar.tech)

5.10 Partial Reset

You can keep the saved parameters and reset the unsaved parameters to factory settings.

The unsaved parameters include renaming, loading RCFGx files, BKG image files, preset parameters, Fn button settings, IP & mask parameters and language settings.

5.11 Communication Settings

5.11.1 Communication Mode

The device is connected to the PC via both USB port and Ethernet port. The communication modes include **USB Preferred** and **LAN Preferred**.

Figure 5-27 Communication mode

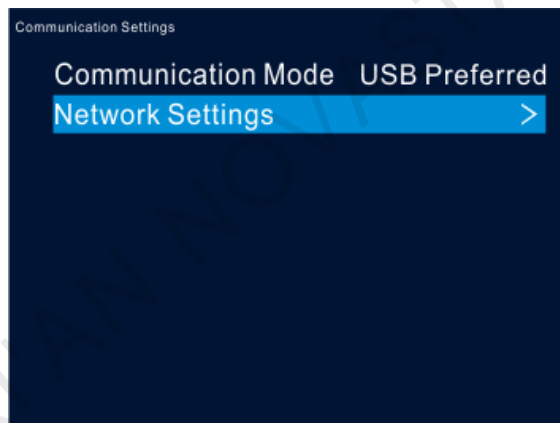

- When USB Preferred is selected, the device communicates with the PC via USB port by preference.
- When LAN Preferred is selected, the device communicates with the PC via Ethernet port by preference.

5.11.2 Network Settings

The network setting modes include **Manual** and **Auto**.

- Manual: Set the device IP address and subnet mask manually.
- Auto: The device reads the network parameters automatically.
- Reset: Reset the parameters to defaults.

Figure 5-28 Network settings

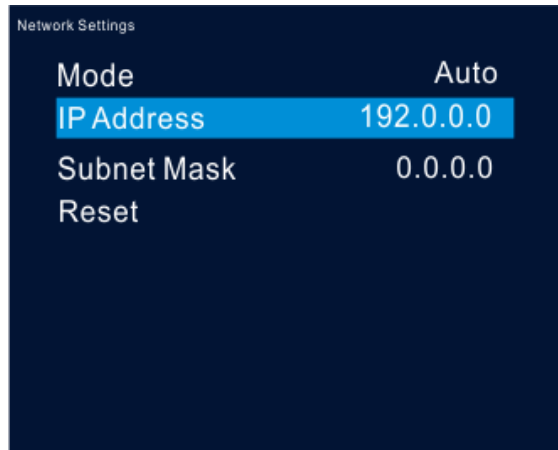
**Note:**

When communicating with the control PC, the device and control PC must be on the same LAN. The IP address of current device cannot conflict with IP addresses of other devices.

5.12 Working Mode

The NovaPro UHD Jr can work as a **Video Controller** (default) or **Fiber Converter**.

Step 1 Press the knob to enter the device menu.

Step 2 Rotate the knob to select **Working Mode** and press the knob to enter the working mode screen to select a desired mode.

- Video Controller: Both Ethernet ports and optical fiber ports are used for output.
- Fiber Converter: Optical fiber ports are used for input, and Ethernet ports are used for output.

Figure 5-29 Video controller mode

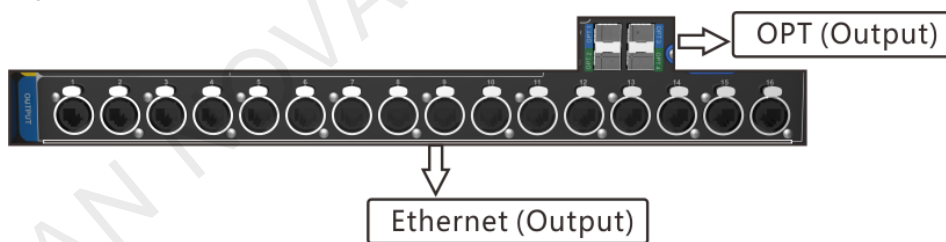
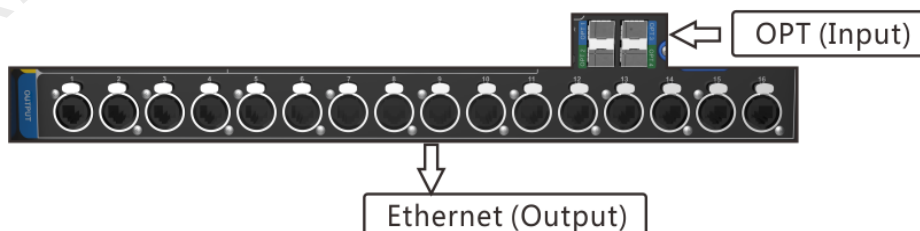

Figure 5-30 Fiber converter mode



5.13 Language

The NovaPro UHD Jr supports both **Chinese** and **English**. You can freely switch to either language.

6 Specifications

Electrical Specifications	Power connector	AC100V–240V 50/60Hz
	Power consumption	70 W
Working Environment	Temperature	0°C–45°C
	Humidity	0% RH–80% RH, non-condensing
Storage Environment	Temperature	-10°C–60°C
	Humidity	0% RH–95% RH, non-condensing
Physical Specifications	Noise Level	46dB (A)
	Dimensions	482.6mm×396.5mm×139.0mm
	Net weight	6.3 kg
	Total weight	13 kg
Packing Information	Packing box	590.0 mm × 270.0 mm × 510.0 mm
	Carrying case	585.0 mm × 265.0 mm × 490.0 mm
	Accessory Box	402.0 mm × 347.0 mm × 65.0 mm
	Accessories	1 × Power cable (EU) 1 × Power cable (US) 1 × Power cable (UK) 1 × Cat5e cable 1 × USB cable 1 × DVI cable 1 × HDMI cable 1 × DP cable 1 × Quick Start Guide 1 × Packing List 1 × Customer Letter 4 × Silicone dust plugs

A

3D Function User Manual

A.1 For Single NovaPro UHD Jr Unit

- Step 1** Select a 3D video source and connect the source to DVI, HDMI or DP connector of the NovaPro UHD Jr unit.
- Step 2** Connect the NovaPro UHD Jr unit to the EMT200 3D emitter and the LED screen in series via Ethernet cables. Then power on the EMT200 and turn on the shutter 3D glasses that come with the EMT200.
- Step 3** Configure the screen. It should be noted that turning on the 3D mode will halve the output loading capacity of each Ethernet port and the whole unit.
- Step 4** Select the 3D video source format. Select Side-by-Side, Top-and-Bottom or Frame Sequential according to the actual video source format.
- Step 5** Adjust the eye priority. Since the left and right eye image switching manner of the video source may not be in sync with your shutter 3D glasses, you need to adjust the eye priority according to actual visual effect after the 3D mode is turned on. The default option is Left.
- Step 6** Adjust the right eye start position.
1. For a side-by-side 3D video source

If the video source resolution is 1920×1080@60Hz, the right eye start should be set to 960. If the video source resolution is 3840×1080@60Hz, the right eye start should be set to 1920. In conclusion, it is recommended you set the right eye start position to the half of the video source width.
 2. For a top-and-bottom 3D video source

If the video source resolution is 1920×1080@60Hz, the right eye start should be set to 540. If the video source resolution is 3840×1080@60Hz, the right eye start should be set to 540. In conclusion, it is recommended you set the right eye start position to the half of the video source height.
 3. For a frame-sequential 3D video source, you do not need to adjust this parameter.
- Step 7** Adjust the signal delay time. Since the left-right eye switching time of the 3D glasses may not be in sync with that of the screen, you need to adjust the signal delay time according to actual visual effect after the 3D mode is turned on.
- Step 8** Turn on the 3D mode. Then only main layer will be kept and other layers will be closed.
- Step 9** Wear your 3D glasses to enjoy 3D effect. No matter how the main layer size or position is adjusted, it always supports 3D effect.

A.2 For Multiple NovaPro UHD Jr Units

- Step 1** Select the 3D video source uniformly for all units and connect the source to DVI, HDMI or DP connectors of all units.
- Step 2** Connect all NovaPro UHD Jr units to the LED screen in series via Ethernet cables, and connect the EMT200 to one of devices via an Ethernet cable. Then power on the EMT200 and turn on the shutter 3D glasses that come with the EMT200.
- Step 3** Configure the load area parameters of each unit. It should be noted that turning on the 3D mode will halve the output loading capacity of each Ethernet port and the whole unit.
- Step 4** Set the image mosaic parameters of each unit, which will not be illustrated in this document.
- Step 5** Select the same 3D video source format for all units. Select Side-by-Side, Top-and-Bottom or Frame Sequential according to the actual video source format.

Step 6 Adjust the eye priority uniformly for all units. Since the left and right eye image switching manner of the video source may not be in sync with your shutter 3D glasses, you need to adjust the eye priority according to actual visual effect after the 3D mode is turned on. The default option is Left.

Step 7 Adjust the right eye start position for all the units to the same value.

1. For a side-by-side 3D video source

If the video source resolution is 1920×1080@60Hz, the right eye start should be set to 960. If the video source resolution is 3840×1080@60Hz, the right eye start should be set to 1920. In conclusion, it is recommended you set the right eye start position to the half of the video source width.

2. For a top-and-bottom 3D video source

If the video source resolution is 1920×1080@60Hz, the right eye start should be set to 540. If the video source resolution is 3840×1080@60Hz, the right eye start should be set to 540. In conclusion, it is recommended you set the right eye start position to the half of the video source height.

3. For a frame-sequential 3D video source, you do not need to adjust this parameter.

Step 8 Adjust the signal delay time. Since the left-right eye switching time of the 3D glasses may not be in sync with that of the screen, you need to adjust the signal delay time according to actual visual effect after the 3D mode is turned on. All units should be set to the same delay time.

Step 9 Turn on the synchronization function and select the current 3D video source as the sync source.

Step 10 Turn on the 3D mode and wear your 3D glasses to enjoy 3D effect.

A.3 Notes

1. Turning on the 3D mode will halve the output loading capacity of each Ethernet port and the whole unit.
2. It is recommended you use the 3D glasses within 3 meter distance from the EMT200.
3. The frame rate of the selected 3D video source should be higher than 60Hz.