

LVP615U

LED HD Video Processor

User Manual

V1.0

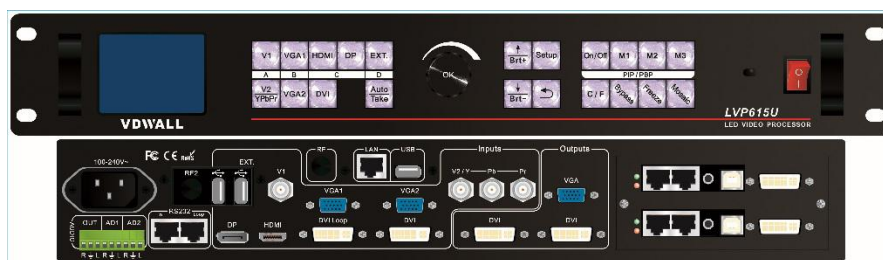

Contents

Chapter 1: <u>Safety precautions</u>	4
Chapter 2: <u>Item list</u>	5
Chapter 3: Hardware connection	
3.1 <u>Rear view</u>	6
3.2 <u>Port description</u>	6
3.3 <u>Hardware connection diagram</u>	8
3.4 <u>Specifications</u>	9
3.5 <u>Product dimensions</u>	11
Chapter 4: Front panel and remote control instructions	
4.1 <u>Front panel buttons and remote control schematic</u>	13
4.2 <u>Remote control operation instructions</u>	15
Chapter 5: Basic user instructions	
5.1 <u>Input signals selection</u>	17
5.2 <u>PIP/PBP operation</u>	21
5.3 <u>Mosaic operation</u>	22
5.4 <u>Other basic user operation</u>	23
Chapter 6: Setup menu instructions	
6.1 <u>Output image setting</u>	26
6.2 <u>Input video signal setting</u>	30
6.3 <u>Text overlay setting</u>	33
6.4 <u>Image quality setting</u>	35
6.5 <u>Audio setting</u>	36
6.6 <u>Communication setting</u>	37
6.7 <u>Language setting</u>	38
6.8 <u>Advance setting</u>	49
6.9 <u>PIP/PBP setting</u>	42
6.10 <u>Mosaic setting</u>	43

Chapter 7: Remote control instructions

7.1	Hardware communication	48
7.1.1	RS232 and USB	49
7.1.2	Wired network	50
7.1.3	WIFI connection	51
7.2	LVP615U series PC control software instructions	58
7.2.1	Control method	58
7.2.2	Software interface instructions	59
7.3	APP remote control	76
7.3.1	Connection	77
7.3.2	APP control instructions	80
Chapter 8 Copyright information		97
Appendix: modify the record table		98

Chapter 1: Safety precautions

! Danger

There is high voltage in the processor, to prevent any unexpected hazard, unless you are maintenance, please do not open the cover of the device.

! Warning

1. This device shall not encounter water sprinkle or splash, please do not place anything containing water on this device.
2. To prevent fire, keep this device far from any fire source.
3. If this device gives out any strange noise, smoke or smell, please immediately unplug the power cord from receptacle, and contact local dealer.
4. **Signal cables are not hot swappable.**

! Caution

1. Please thoroughly read this manual before using this device, and keep it well for future reference.
2. In the event of lighting or when you are not going to use the device for a long time, please pull the power plug out of receptacle.
3. Nobody other than professional technicians can operate the device, unless they have been appropriately trained or under guidance of technicians.
4. To prevent equipment damage or electric shock, please don't fill in anything in the vent of the device.
5. Do not place the device near any water source or anywhere damp.
6. Do not place the device near any radiator or anywhere under high temperature.
7. To prevent rupture or damage of power cords, please handle and keep them properly.







8. Please immediately unplug power cord and have the device repaired, when
- 1) Liquid splashes to the device.
 - 2) The device is dropped down or cabinet is damaged.
 - 3) Obvious malpractice is found or performance degrades.

Chapter 2 Item List

Please unpack the product carefully, then check whether all the following things are included in the package. If anything is found missing, please contact the dealer.

Standard accessories

The accessories supplied with this LED Video Processor may differ from the figures contained in the **User's Manual**, but they are applicable for the regions where you live.(LED sending card is optional)

<p>1.5m power cord*1</p> 	<p>1.5m DVI cable*1</p> 	<p>0.5m DVI cable*1</p> 
<p>1.5m RS232 to RJ45 adapter cable*1</p> 	<p>User manual *1</p> 	<p>CD*1</p> 
<p>Remote control *1</p>	<p>Audio connector *1</p>	<p>BNC-RCA adapter *3</p>



Chapter 3 Hardware connection

3.1 Rear view

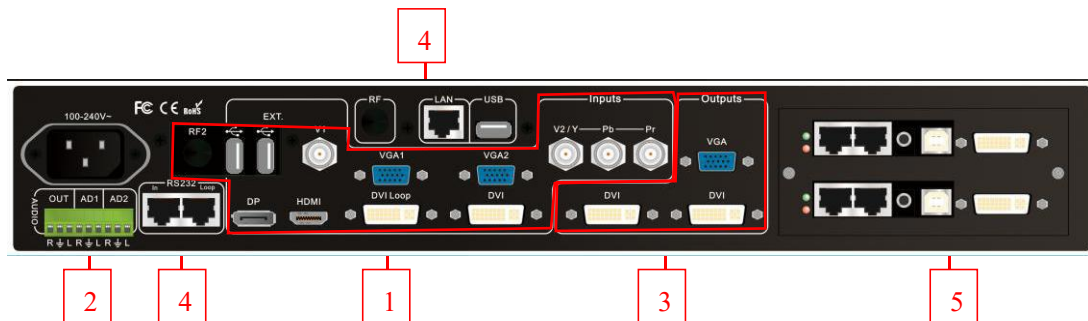

3.2 Ports description

3.2.1 Video signal inputs (INPUT)

LVP615U supports 8 video signals input as follows:

Port	Description
------	-------------

V1	1*Composite Video (PAL/ NTSC)
V2 / YPbPr	1* Composite video (PAL/ NTSC) or analog component video input
VGA1~VGA2	2 * PC analog signal
DVI	1* DVI (PC digital signal)
HDMI	1*HDMI (HD digital signal)
DP	1*DisplayPort(digital signal input)
EXT.	1* Extended PAL/NTSC composite video input

3.2.2 Audio input signals (AUDIO)

LVP615U supports 5-channel stereo audio inputs switching. Of which, 3channels are DP, HDMI and USB input. The other 2 channels are AD1, AD2 external audio input. AD1 and AD2 can be mapped to any one of signal inputs, and will be switched synchronous to the selection of video input signals.

3.2.3 Video signal output

Port	Description
VGA OUT	1-channel analog RGBHV signal output, which can be connected to a local display device for monitoring (it is strongly recommended to use this port when operating and setting LVP615U).
DVI OUT1 / DVI OUT2	2 same DVI digital graphic signal output, it can be connected to external 2 LED transmission cards or LED transmission boxes.
DVI Loop OUT	1-channel computer DVI digital signal loop output

3.2.4 Other ports

Port	Description
LAN	TCP/IP local area network control interface
USB	USB communication port
RS232 IN	Serial communication interface, used to connect the RS232 port of PC to realize PC software control.
RS232 LOOP	Serial communication cascading output for connecting the RS232 IN of next unit, through single PC can control several units.
RF	Antenna interface of wireless control function
RF 2	Network intelligent module

3.3 Hardware connection diagram

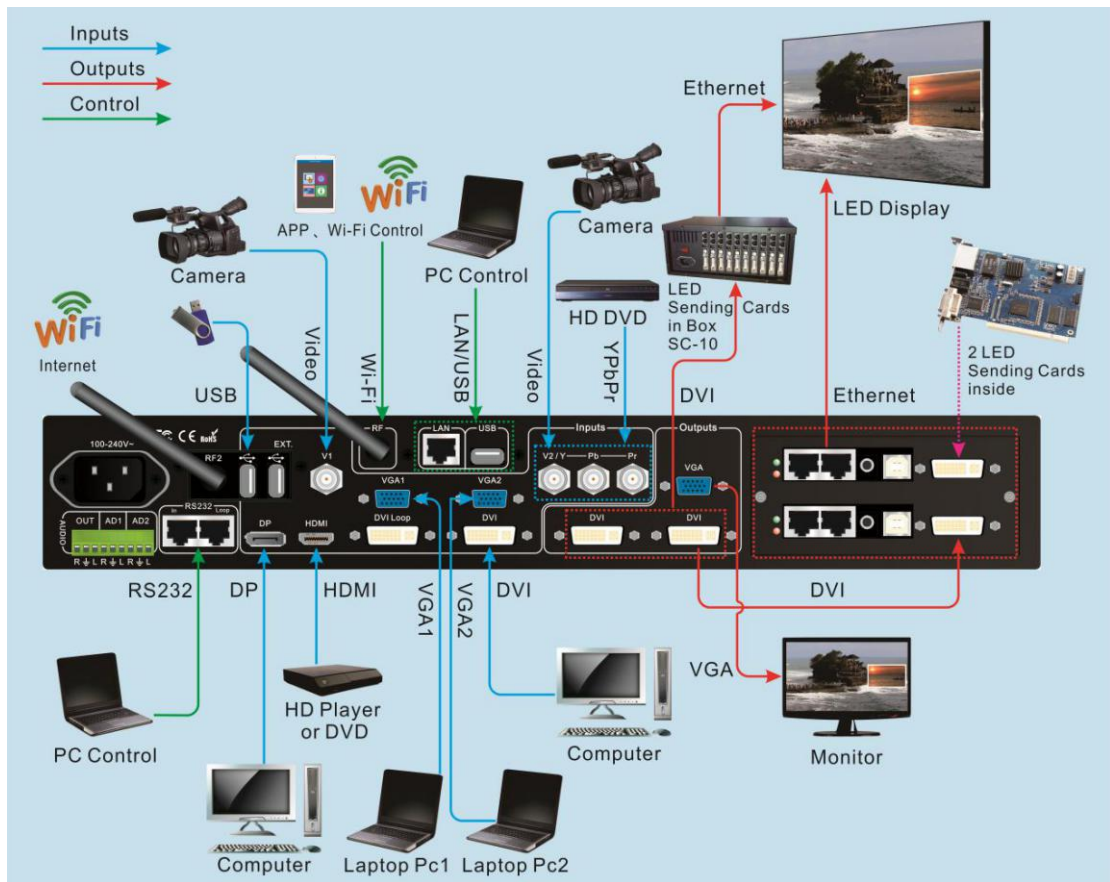

3.4 Specifications

Inputs		
Nums / Type	2×Video 1×YPbPr 2×VGA (RGBHV) 1×DVI (VESA /CEA-861) 1×HDMI (VESA /CEA-861) 1×DP (VESA) 1*EXT (USB)	
Video system	PAL/NTSC	
Composite Video Amplitude Impedance	1V (p_p) / 75Ω	
VGA format	PC (VESA standard)	≤2048×1152_60Hz
VGA Amplitude Impedance	R、G、B = 0.7 V (p_p) / 75Ω	
YPbPr format	SD/HD (CEA -861)	≤1920x1080p_60Hz
YPbPr Amplitude Impedance	Y=1V (p_p) / 75Ω Pb= 0.35V (p_p) / 75Ω Pr= 0.35V (p_p) / 75Ω	
DVI format	PC (VESA standard)	≤2304×1152_60Hz
	Custom output format	Width≤3840 , Height≤1920
HDMI format	PC (VESA standard)	≤1920×1080_60Hz
	HDMI1.3 (CEA-861)	
DP format	Display Port 1.1 (VESA standard)	≤1920×1080_60Hz
USB	video format	MKV/TS/M2TS/TP/TRP/AVI /WMV/RM/RMVB/MPEG/MPG/MP4/VOB/MOV/ISO/DAT/ASF
	Video encoding format	H.265 AVC HD、VC-1(WMV HD) 、 MPEG-2 HD 、 MPEG-1、MPEG-4、Xvid

LVP615U 使用说明

	Picture format	JPG 、 PNG 、 BMP , max resolution 15million.
Input connectors	Video: BNC YPbPr: BNC×3 VGA: 15pin D_Sub(female) DVI: 24+1 DVI_D HDMI: HDMI port A type DP: Display Port USB:USB A type	
VGA/DVI format	1024×768_60Hz/75Hz 1280×1024_60Hz/75Hz 1600×1200_60Hz 1920×1080p_50Hz/60Hz 1366×768_60Hz 1440×900_60Hz 2048×1152_60Hz 2560×816_60Hz 2304×1152_60Hz 1920×1200_60Hz 1200×1600_60Hz 1080×1920_60Hz 1536×1536_60Hz Custom output format (maximum horizontal pixel:3840, maximum vertical height:1920)	
Output connectors	VGA OUT:15Pin D-sub(female) DVI OUT1: 24+5 DVI_I DVI OUT2: 24+1 DVI_D	
Others		
Control	RS232/USB/LAN/WIFI/Remote control	
Input voltage	100-240VAC 50/60Hz	
Power consumption	≤25W	
Environment Temperature	0-45 °C	
Environment Humidity	15-85%	

LVP615U 使用说明

Product Size	483(L) x 274(W) x 66.6(H)mm
Weight	G.W.: 5.7 Kg, N.W.: 4.2Kg

3.5 Product dimensions

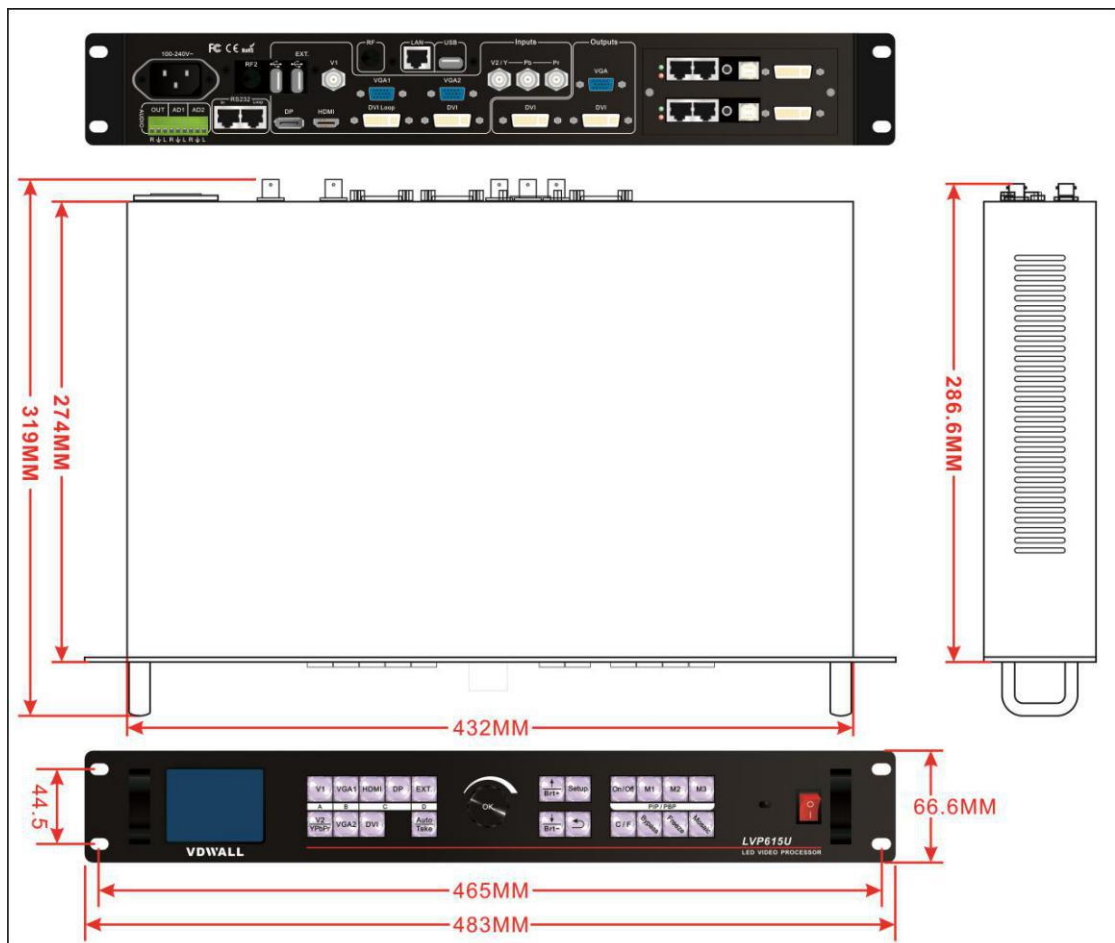

RS232 cable order:

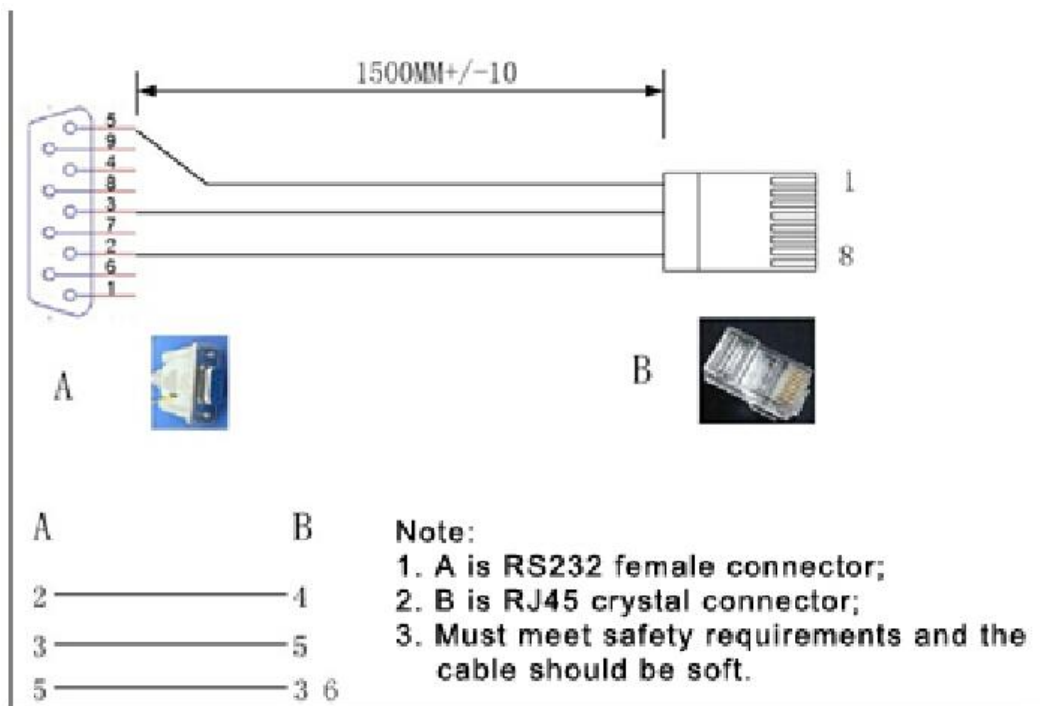

Chapter 4 Front panel and remote control instructions

LVP615U supports front panel button, remote control, RS232 and LAN control. Same printing on remote control buttons and front panel buttons, same button functions. The instructions are as below.

4.1 Front panel buttons and remote control schematic

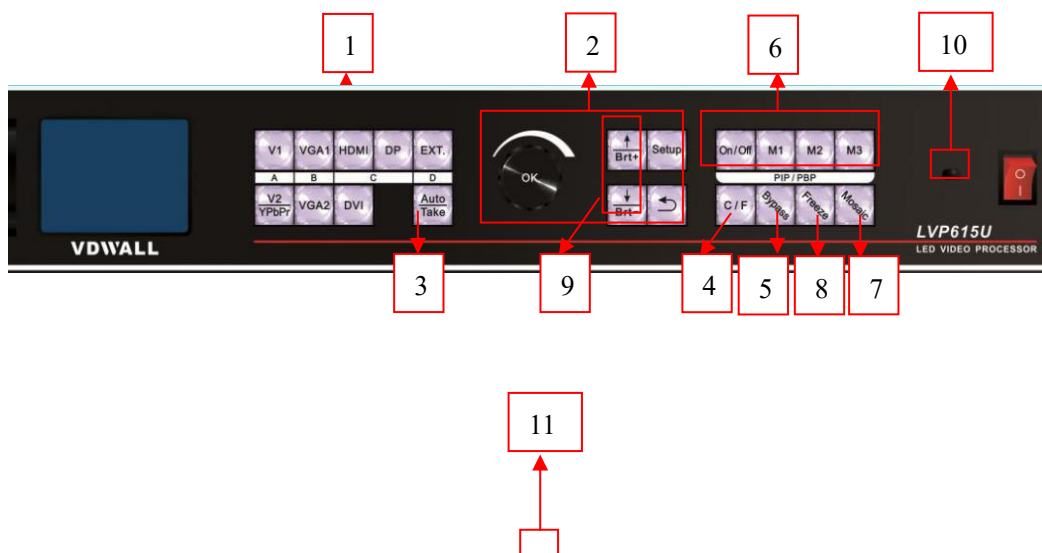

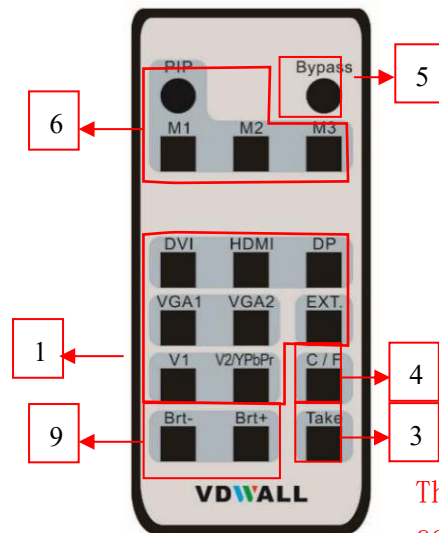

The buttons on remote control have the same functions as the relative buttons on front panel.

4.1.1 Input signal selection buttons



select the input signal.

4.1.2 Setup buttons (Setup , \downarrow Brt- , \uparrow Brt+ , OK , \rightarrow), Set the output image parameters.

4.1.3 VGA auto adjustment button ($\frac{Auto}{Take}$) automatically adjust the VGA input signal.

4.1.4 Switching time setup button (C/F): select seamless switching time including 0 second (cut), 0.5 second, 1.0 second and 1.5 second (fade in fade out) and blend switching function.

4.1.5 PC signal bypass output (): Switch between part and full display of PC signal. The indicator shows the current state of the input signal.



4.1.6 PIP/PBP keys (, , , ):

: **PIP/PBP** turn on/ off button. When the indicator is on, press input signal selection to choose different group input or current input itself as the PIP signal.

, , : Switch PIP/PBP model.

4.1.7 Mosaic button () Turn on /off mosaic function. The indicator shows the current state of mosaic.

4.1.8 Freeze button () turn on / off freeze function.

4.1.9 Brightness adjustment button (, ) adjust output brightness level under user operation station.

4.1.10 remote control sensor: built- in infrared receiver.

4.1.11 remote launch window: built-in infrared transmitter.

4.2 Remote control operation instructions

- 4.2.1 Open the battery compartment on the back of the remote control, make sure the battery effective contact
- 4.2.2 Please aim remote control to the sensor area of LVP615U, if there is obstacle between them, LVP615U may not receive command.
- 4.2.3 To make sure remote control has a good performance. If found improper operation, please replace new battery immediately.
- 4.3.3 Batteries shall not be exposed to, such as sunlight, fire or the like overheated environment.









Chapter 5 Basic user instructions

After LVP615U boot, it enters the operation status of last shut-down including signal switching status, PIP/POP (or Text overlay) status and mosaic status. Among them, PIP/PBP(or text overlay) status and mosaic status can only realize relative functions and cannot do other operation. Other relative operations are available under signal switching status. We illustrate the common operations as below.

5.1 Input signals selection

LVP615U supports two signal switching methods including “**One key switching**” and “**Pre.+Take switching**”. The switching method can be set in user setup menu “2.6 switch mode”. “**One key switch**” is default method. One key switch to new input signal through input signal selection buttons.; “**Pre.+Take switch**” only available for seamless switching. Press input buttons to preselect first. Then press **Take** button to switch from current input signal to preselected signal.

Input signal selection as follows:

Buttons	Description
	1* Composite video signal input (PAL/ NTSC)
	1* Composite video (PAL/ NTSC) or analog component video input
 	2 * PC analog signal input
	1*DVI digital signal input
	1 * HDMI digital signal input
	1* DisplayPort digital signal input
 *	1* extended signal input

Note: (1) YPbPr and V2 share the same port. If need,configure the port to YPbPr in setup menu.

5.1.1 One key switch

LCD screen display as below:

Input:	HDMI
In Status:	1080p_60Hz

Output Size:	1920x1080
Output Start:	(0, 0)

Switch Mode:	One Key SW.
Switch Time:	1.5 Sec

After select input signal, The first line on the LCD display the current input signal. Like: “ Input: **HDMI** ” 。 The second line on the LCD display the signal status.If no active input, display” No input’. Meanwhile,the corresponding indicator flicker. Led screen is black. If active input, display input signal format Like: “ 1080p_60Hz ” 。

5.1.2 Pre.+Take switch

LCD screen display as below:

```

Curr. Input:      HDMI
Curr. In Status: 1080p_60Hz
Pre. Input:       V1
Pre. In Status:  PAL
-----
Output Size:      1920x1080
Output Start:     (0, 0)
Switch Mode:      Pre.+Take SW.
Switch Time:      1.5 Sec
    
```

Switching signal method: press input button to preselect first, LCD screen displays the current input status and preselect input status. Then press **Take** button to switch current input to preselect input. After the completion of switching, preselect signal become the current input signal. The status of the preselect signal indicator: when the signal is valid, the indicator flicker rapidly. when the signal is invalid, the indicator flicker slowly.

Note : **Pre.+Take switch** only available for seamless switching. **LVP615U** supports seamless switching between any two different input groups as follow. Same group does not support seamless switching. For example, current input is V1(V1 in group A). Then, preselect signal is only from B,C,D group. Signal group as follow. :

A	B	C	D
V1、V2	VGA1、 VGA2	DVI、 HDMI、DP	EXT

5.1.3 Switching time setting (C/ F)

LVP615U 使用说明

In the signal switching status, press **C/F** button continually can change the current seamless switching transition time. LVP615U can achieve seamless switching between any two different input groups of four input groups. Switching effect includes seamless switching (0s), Fade in/ Fade out (0.5s 1s 1.5s) and blend switching.

Seamless switching (**Cut**): On the LCD“Switch time” is 0s. **LVP615U** default switching is CUT.

Fade in fade out (**Fade**): On the LCD“Switch time”is **0.5s**、**1.0s** or **1.5s**. In this mode, different group signals support fade in fade out switching.

Blend switching: at this moment, on the LCD, current input is the main input. Select different group input signal as blend signal. The main input will overlay in the blend signal. Press blend signal or main signal button again. Then switch to selected signal. The whole process is fade in fade out effect.

```
Main Input:      HDMI
Main In Status: 1080p_60Hz
Blend Input:     V1
Blend In Status: PAL
-----
Output size:    1920x1080
Output start:   (0, 0)
-----
```

Note: 1. **YPbPr** does not support seamless switching, fade in fade out or blend switching. Switching between any signal and **YPbPr** signal will cause black led screen.

2. Blend switching is only for signal switching. For other operations, press C/F to exit the blend switching state.

5.2 PIP/PBP operation

LVP615U allows to insert PIP window on the current display signal. That is dual image display function(PIP/PBP)。PIP signal can be any input signal from other input groups or current input signal itself. (signal group refer to page 19[signal group list](#)) Dual image size can be preset 3 modes.The detailed operation method is as follow:

Enter PIP/PBP mode: press **On/Off** button, the indicator will be on. LVP615U enters PIP/PBP mode. Then press input signal button to select PIP signal. At the same time, LCD will display main input and pip input status and size. (as shown below)

```
Main Input:      HDMI
Main In Status:  1080p_60Hz
PIP Input:       VI
PIP In Status:   PAL
-----
Main Output Size:  1920x1080
Main Output Start: (0, 0)
PIP Output Size:   640x320
PIP Output Start:  (16, 16)
```

Select PIP input signal: In **PIP** mode, press button to select corresponding signal. Then this signal is configured as **PIP input**.

Select Main input signal: Press **On/Off** button to close PIP mode., Press button to select corresponding signal as main input signal. Then press **On/Off** button to enter **PIP** mode to select pip signal again.

Switch PIP/PBP mode: When PIP/PBP is on, press buttons **M1**、**M2**、**M3** directly to select display mode fast.

5.3 Mosaic operation

Multiple units LVP615U cascading can drive huge resolution LED screen. Only when the current input is DVI, press **Mosaic** button and the indicator is on. **LVP615U** enters to Mosaic operation. Press the button again and the indicator is off, **LVP615U** exits Mosaic.

```
Mosaic Input:      DVI
In Status:        1080p_60Hz
Input Image Size: 960x540
Input Image Start: (0, 0)
-----
Mosaic out size:  1920x1080
Mosaic out start: (0, 0)
Mosaic PIP:      off
-----
Device ID:       1
```

Note:

5.3.1 In mosaic mode, PIP display is available.

5.3.2 In following conditions , **LVP615U** cannot enter mosaic status.

- (1) The input signal selected is not DVI;
- (2) Bypass is on;
- (3) The resolution of DVI input signal is different from the output resolution of processor.

5.4 Other basic user operation

5.4.1 Brightness selection (Brt+, Brt-)

LVP615U supports 64 level or 100 level brightness selection. According to “8.5 bright level” selection, adjustment range has two kinds: **0~64** or **0-100**. Factory default is **0-64**. To make sure of full gray scale of output image, it always set as 64 (0-100 default value is 50) !

button	description
BRT-	Reduce LVP615U output brightness, the lowest is 0.
BRT+	Increase LVP615U output brightness, the highest is 64 or 100.

5.4.2 VGA input auto adjustment (Auto)

When LVP615U is in one key switch status and current valid input signal is VGA, press **Auto** button to adjust VGA input signal sampling parameters. Then the VGA output image can be clear and full.

This operation is normally performed when a new VGA source is connected. Auto adjustment time is depend on the signal status.

Normally it's less than 1 second. Sometimes it's necessary to perform several times until the output image is clear, full and stable.

5.4.3 Full/ part display (Bypass)

In signal switching status, press **Bypass** button to switch full and part display.

This function only works when current signal is **PC** input signal (**VGA1/ VGA2/ DVI /HDMI /DP**). Fixed other signals to **Full** mode.

state	description
Full	Full display,the input image is compressed and fully displayed on the led screen and the indicator is off.
Part	Part display, the input image is not compressed.Only a part of it can be displayed on the screen and the indicator is on.

Note:When the width and height of input image are lower than the LED screen real width or height value. Part display is invalid.

5.4.4 Text overlay

LVP615U allows for overlapping text, logo or flash on the current image. The operation is as below.

When the current input display properly, enter setup menu "3.Text overlay", set "3.1text overlay" on, then select text source.Text can be produced by PowerPoint and other office software.

5.4.5 Image freeze (Freeze)

Press **Freeze** button and the indicator is on, the current image is frozen. Press **Freeze** button again or switch to another signal to exit Freeze status.

5.4.6 Device information view (OK)

In signal switching status, press **OK** to check the LVP615U current setting and information.

```
System info
-----
model:          LVP615U
version:        V0.0.8/V0.0.8
IP:            192.168.1.8
Mask:          255.255.255.0
Gate:          192.168.1.1
MAC:           76-64-77-00-00-00
Device ID:     1
```

Chapter 6: Setup menu instructions

Setup menu is to set the entire processor. There are 9 section including **output image**、**input image**、**text overlay**、**image quality**、**audio**、**communication**、**language**、**advance**、**PIP/PBP**、**mosaic**.

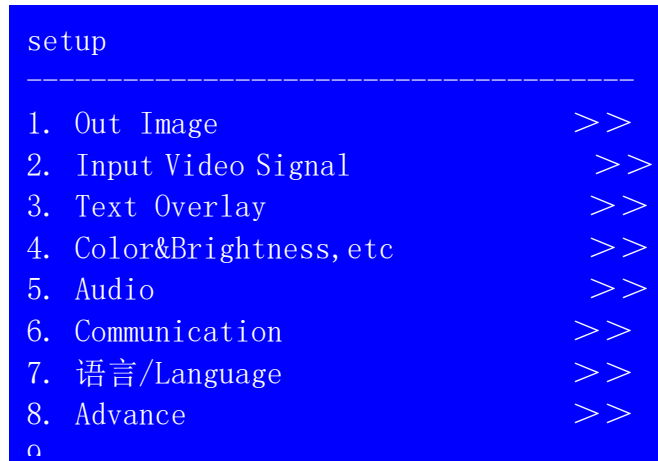

After the system starts, Press **Setup** to enter the setup menu. Then press **↑, ↓** button to select the corresponding menu item to be set. Press **OK** button to enter and **⏪** return back upper level menu. The following is a detailed description of each menu function:

6.1 Output image setting

Press **Setup** to enter setup menu. Press **↑, ↓** button to select "1. Out

image” item. Then press **OK** button to enter the following image “1. Out image” item.

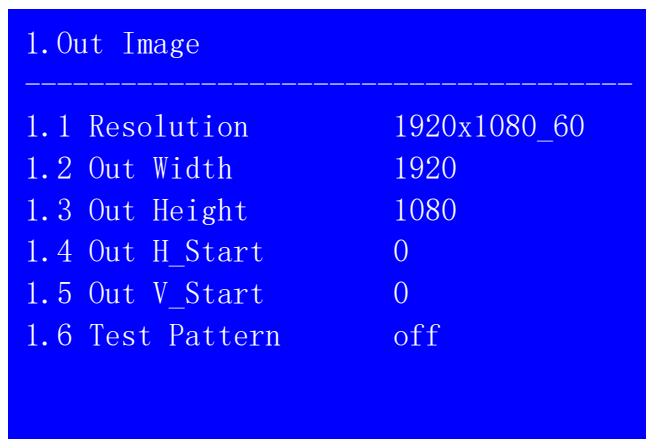

1. Out Image	

1.1 Resolution	1920x1080_60
1.2 Out Width	1920
1.3 Out Height	1080
1.4 Out H_Start	0
1.5 Out V_Start	0
1.6 Test Pattern	off



6.1.1 Set output format

LVP615U can output image from the VGA OUT and 2 DVI OUT. There are 16 fixed output format and custom output format. (refer to page 9 specifications). Users can select fixed output format not less than the LED screen resolution or select custom output format which can realize pixel to pixel display in concert with **2.1.1 custom DVI EDID**.

Operation steps:

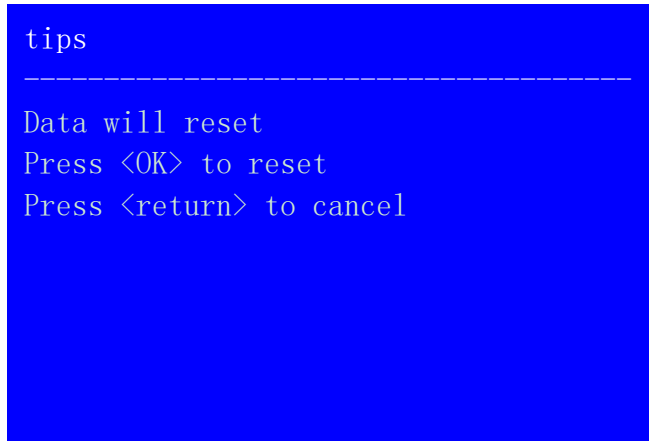
Press **↓** to select “1.1 Resolution” item. Rotate **knob** to select suitable output format, like “1280×1024_60”, Press **OK** button, the screen will display confirmation menu. Press **OK** button again to confirm the output format. The device will restart automatically.



Note: to *custom output format*, after selection, need further set 1.1.1 custom width, 1.1.2 custom height and 1.1.3 custom V frequency. Press  button to 1.1.4 Apply, Press  to make parameters effective.

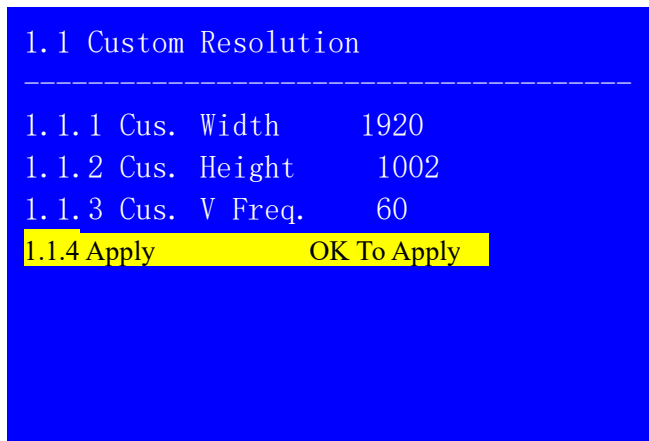

6.1.2 Set output image parameters

LED screen real resolution can be arbitrary. So we need set **LVP615U** to output the same image as the led screen. Then the LED screen can display whole image.

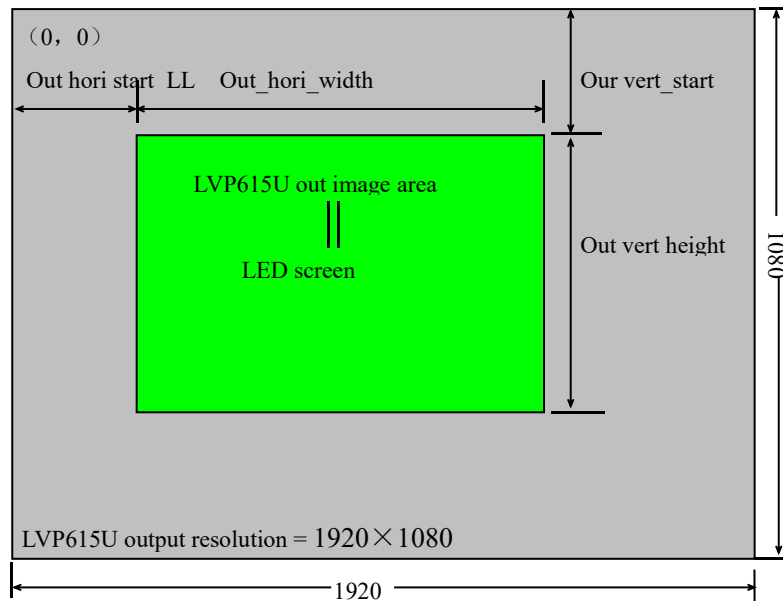

As shown in the above picture: the size and location of output image of **LVP615U** can be defined in 4 parameters:

Item NO.	Item name
1.2	<i>Out_hori_width</i>
1.3	<i>Out_vert_height</i>
1.4	<i>Out_hori_start</i>
1.5	<i>Out_vert_start</i>

Note: current set parameters can be changed by rotating **knob**. **knob** rotating speed can decide the step value. Press "**OK**" button to save the set parameters.

6.1.3 Test pattern

LVP615U can generate 36 test patterns for LED screen testing.

If this item value is “off”, turn off Test pattern. Select other number and confirm. Then one corresponding test pattern of 36 pcs will be selected.

Operation steps:

Press ↓ button to select “1.6 Test pattern” item, then rotate **knob** to select suitable test pattern number and press “**OK**” to apply the test pattern.

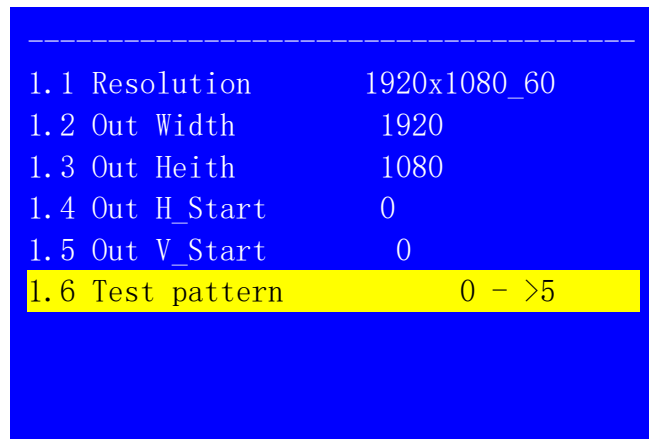

Note: The current signal must connect valid input. Then the test pattern has output. Otherwise no output.

6.2 Input video signal setting

Press **Setup** button to enter setup menu. Press **↓** button to select 2. Input video signal and press **OK** to enter this item.

```
2. Input video signal
-----
2.1 DVI EDID          1280x1024_60
2.2 V1/V2 backup     off
2.3 VGA1/VGA2 backup off
2.4 HDMI/DVI backup  off
2.5 V2 or YPbPr      V2
2.6 Switch mode      one key switch
```

6.2.1 DVI EDID

LVP615U supports custom DVI EDID. In concert with “**custom output format**”, LVP615U can realize DVI input image and output image pixel to pixel display. LVP615U supports 16 fixed DVI EDID and custom EDID. Normally the parameters setting should be consistent with “**custom output format**” (refer to page28).

Operation steps: In the menu 2.1 DVI EDID, rotate **knob** to select suitable resolution and press **OK** to save data. After save data, need press **OK** to enter “2.1 custom DVI EDID” menu to set 2.1.1 custom width、2.1.2 custom height and 2.1.3 custom V frequency and press **↓** to enter APPLY and press “**OK**” to make parameters effective.

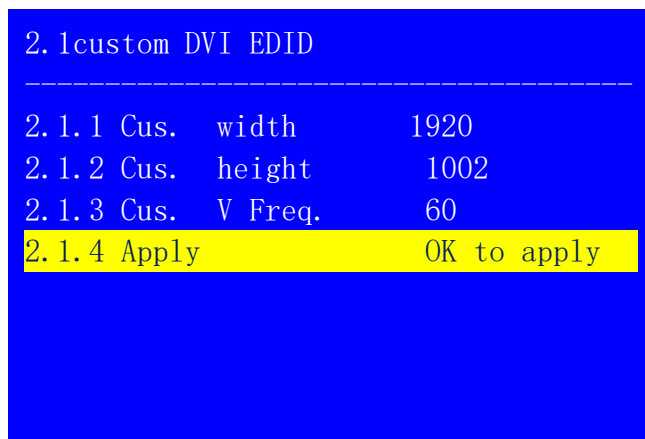

A screenshot of a blue menu interface for LVP615U. The menu is titled "2.1 custom DVI EDID" and lists several settings. The last option, "2.1.4 Apply", is highlighted in yellow.

2.1 custom DVI EDID		
2.1.1 Cus.	width	1920
2.1.2 Cus.	height	1002
2.1.3 Cus.	V Freq.	60
2.1.4 Apply		OK to apply

6.2.2 Hot spare setting

LVP615U supports hot spare of input signals. When the current input signal is lost, LVP615U will switch to the spare signal automatically to avoid image interruption caused by the fault of signal source.

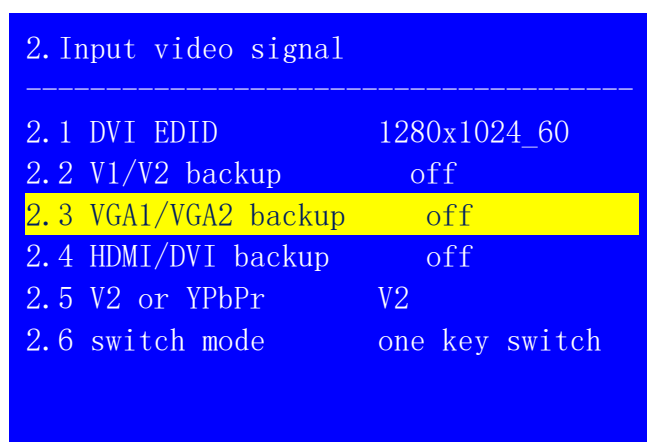

A screenshot of a blue menu interface for LVP615U. The menu is titled "2. Input video signal" and lists several settings. The option "2.3 VGA1/VGA2 backup" is highlighted in yellow.

2. Input video signal	
2.1 DVI EDID	1280x1024_60
2.2 V1/V2 backup	off
2.3 VGA1/VGA2 backup	off
2.4 HDMI/DVI backup	off
2.5 V2 or YPbPr	V2
2.6 switch mode	one key switch

As shown in the above table, if "2.2 V1/V2 backup on", if V1 signal is lost, processor will switch to V2 automatically.

6.2.3 V2 or YPbPr selection

V2 and YPbPr of LVP615U share the same port and button. Need configure. Default input is V2. If need YPbPr input, then need set this

port to YPbPr.

Operation steps:

In the menu of 2.5 V2 or YPbPr, rotate knob to select needed parameters and press "OK" to make them effective.

6.2.4 Signal switch mode

Press Setup to enter setup menu, press ↓ to select "2. Input video signal", Then press OK to enter "2. Input video signal", and press ↓ to select signal switch mode "**one key switch**" or "**Pre.+Take switch**", Press OK to apply.

```
2. Input video signal
-----
2.1 DVI EDID          1280x1024_60
2.2 V1/V2 backup     off
2.3 VGA1/VGA2 backup off
2.4 HDMI/DVI backup  off
2.5 V2 or YPbPr      V2
2.6 switch mode      Pre.+Take SW. ?
```

6.3 Text overlay setting

```
3.Text overlay
-----
3.1 Text overlay      off
3.2 Text source      ?
3.3 Text mode        < threshold
3.4 Threshold R      8
3.5 Threshold G      4
3.6 Threshold B      8
```

6.3.1 Text overlay operation

In the current input signal, press **Setup** and press **↓** to select "3.text overlay", Press **OK** to enter, in the menu "3.1text overlay" rotate **knob** to switch it on. Then press **↓** to enter "3.2text source" menu to rotate **Knob** to select text input signal. Text overlay is on. If need turn it off, enter 3.1 text overlay and switch it off.

6.3.2 Text overlay parameters setting

3.1Text mode: LVP615U can custom text mode < threshold or > threshold. < threshold means text signal image which is less than the current threshold value will overlay on the current signal. The bigger part will be automatically filtered out. > threshold means

text signal image which is bigger than the current signal will overlay on the current signal.

Threshold R /G/B : This is used to set three thresholds subtitles red, green and blue respectively for a particular value between 0 to 248.

The following is the text overlay example. Text file is made by Powerpoint. Parameters are as follow:

3.3	Text mode	<threshold
3.4	Threshold R	248
3.5	Threshold G	248
3.6	Threshold B	248



Main picture

text

text overlay

6.4 Color& Brightness,etc.

```

4. Color&Brightness                               Default
-----
4.1 Input color                                   50
    V1=50                                         V2=50
    HDMI=50                                       DVI=50
    DP=50                                         EXT=50
    V1=50
    All=50
4.2 Sharpness                                    normal
    
```

```

4. Color&Brightness                               Default
-----
4.3 Brightness                                   50      50
    
```

LVP615U supports custom color,sharpness and brightness setting.

List as follow:

Item name	Definition
4.1 color	Adjustment range: 0~100, default 50

4.2 sharpness	Normal or sharp, default : normal.
4.3 brightness	According to "8.5 brightness level" setting, adjustment range includes 0-64 or 0-100 . The factory default of adjustment range is 0-64 and default is 64. "Brightness level" can be set in factory setting.

Note: 1). To make sure of full gray scale of output image, these output parameters are set as default.

2). Color parameters are invalid for RGB format DP, DVI and HDMI. VGA is RGB format. So setting is not available.

6.5 audio setting

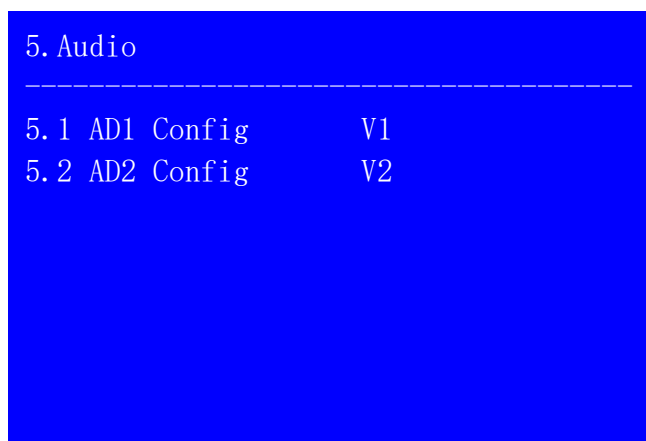

LVP615U supports 4 channels of stereo audio input signals. Three of them are HDMI and DP audio. The other two AD1 and AD2 are external input. Audio input signals for AD1 and AD 2 can be configured to match the video input signals correspondingly and switching between AD1 and AD2 is synchronous to that between the video inputs.

Operation way:

Press **↓** button to select **5.1 AD1 config** or **5.2 AD2 config** menu, Rotate **knob** to select corresponding input signals and press **OK** to

save.

If **HDMI** (or **DP**) is configured as external audio input, processor will select external audio input signal when switching to **HDMI** (or **DP** Otherwise, it will select **HDMI** (or **DP**) itself audio as input.

1、 6.6 Communication

```
6. Communication
-----
6.1 IP:           192.168.1.8
6.2 mask:         255.255.255.0
6.3 gate:         192.168.1.1
6.4 Mac:          76:64:77:00:00:00
-----
6.5 device ID    1
```

LVP615U can be remotely controlled via Ethernet. Communication setting menu is used to set network parameters including IP address, mask, gate, MAC and number the multiple LVP615U under the same IP.

The following is the method of operation:

In the menu of "6. Communication", press  to enter the setting,

rotate **knob** to select parameters and press **OK** to save. The LCD screen will give tips to restart the system and do according to the prompt.

6.7 Language setting

LVP615U supports Chinese and English language. Rotate **knob** to select one and press **OK** to save.



The screenshot shows a blue LCD screen with white text. At the top, it says "7. Language". Below this, there is a horizontal dashed line. Under the line, it says "7.1 语言 Language Chinese".

2、 6.8 Advance setting

8. advance	default
8.1 ADC calibration	OK to apply
8.2 Bias 50	50
8.3 EXT. Input model	EXT. VIDEO
8.4 De-Interlace	off
8.5 Bright level	0-64
8.6 DVI hotplug	off
8.7 Wifi reset	OK to apply
8.8 Device reset	OK to apply

6.8.1 ADC Calibration

“8.1 ADC Calibration” is used to calibrate the white balance of analog signals to avoid color cast or extreme darkness problem. This function is only available for non ext. Input VGA,CVBS and

YPbPr. The operation way is as follow:

In the current available Analog signals, enter “8.1 ADC calibration” and press **OK** to start to calibrate.

Note : Processors finished white balance calibration before leaving factory. Please use this item carefully.

6.8.2 Bias

To reduce noise of low gray scale images, LED display system normally will remove the low gray scale part from input signals. But this will also bring information loss of images, especially dark images like night scenes.

LVP615U can adjust “ 8.2: Bias ” parameters to adjust. The value range is : 0— 100. In the case dark image information lost, adding this value will bring back the lost information and fully display the image on LED display.

Note: to make sure of full gray scale of output image, the default value is 50.

6.8.3 EXT. Input Model

The option is used to configure extended module after replacing it, to make sure the module can work normally. Operation is as below:

Entering “8.3 EXT. Input Model” option, rotate knob to select relative option, press **OK** button to save. The setting will be active after restarting.

6.8.4 De-Interlace

This option is used to remove trembles, which might happen when inputs are CVBS/S-Video/HDMI/SDI signals interlace signals (e.g.: 1080i) and used as PIP.

Operation is as below:

Enter “8.4 De-Interlace”, rotate knob to select “On”, press “OK” button to make setting active.

6.8.5 Brightness Level

Bright level	Description
0-64	0 is minimum brightness, 64 is default standard brightness.
0-100	Allow higher brightness value: 0 is minimum and 50 is default value.

According to different demands, user can select relative “Bright Level”.

“8.8 Device Reset” will not change the parameter of “bright level”. When multiple units doing cascading splice, all units must be same “bright level”. Operation is as below:

Enter “8.5 Bright Level”, rotate knob to select “0-64” or “0-100”, and press “OK” button to confirm the setup.

6.8.6 DVI hotplug

“DVI hot plug signal” is sent by processor to graphic card or other signal source devices, as a gist to let the signal source device whether outputs DVI signal source or not. A few PC when use some software play video on extended desktop, the “hot plug signal” to the device may cause the player out of order on extended desktop. If this happens, please enter setup menu “8.6 DVI Hotplug” to turn this function off.

1) 6.8.7 Wifi reset

The menu item is used for resetting LVP615U's Wifi module parameter. Operations as below:

Enter "8.7 Wifi Reset", press "OK" button, there is one information on LCD screen to remind you data will reset. Press OK button to apply. LVP615U starts to reset..

8) Device Reset

The menu is used to initialize LVP615U. Operation as below:

Enter "8.8 Device Reset" and press OK button, there is one information on LCD screen to remind you data will reset. Press OK to apply. LVP615U will reset and restart.

6.9 PIP/PBP setting

D. PIP/PBP	Mode=M1
D. 1 PIP Width	640
D. 2 PIP Height	320
D. 3 PIP H_Start	16
D. 4 PIP V_Start	16
D. 5 MAIN Width	1920
D. 6 MAIN height	1080
D. 7 MAIN H_Start	0
D. 8 MAIN V_Start	0

The setup option is used to set LVP615U's three user defined **PIP/PBP** mode. Operation as below:

When LVP615U's PIP/PBP status is open (the indicator light on "On/Off" button is lit up), press **Setup** button, LVP615U enters "D. PIP/PBP" menu. Then press

mode button (M1, M2 or M3) to select a mode to save parameters, press ↓ to select parameter option needed to adjust. For example “D.1 Main Width”, rotate **knob** to change parameter, press **OK** button to save.

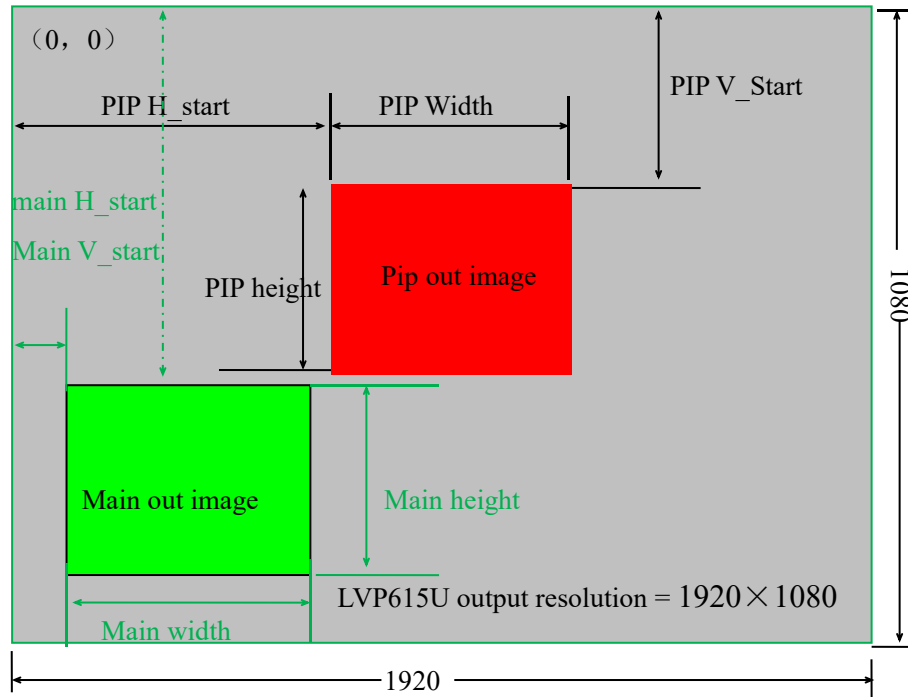

6.10 Mosaic setting

E. Mosaic (Video Wall App)

E.1 LED Total Width	3840
E.2 LED Total Height	2160
E.3 Unit Width	1920
E.4 Unit Height	1080
E.5 Unit H_Start	0
E.6 Unit V_Start	0
E.7 Sync. Mosaic	ON
E.8 Auto Calculation	OK To Apply

E. Mosaic (Video Wall App)			
E. 9	In Width	960	960
E. 10	In Height	540	540
E. 11	In H_Start	0	0
E. 12	In V_Start	0	0
E. 13	Out Width	1920	1920
E. 14	Out Height	1080	1080
E. 15	Out H_Start	0	0
E. 16	Out V_Start	0	0

LVP615U can maximally output 2304*1152 or customized resolution with maximal horizontal 3840 pixels or vertical 1920 pixel. To drive such high definition, LED display requires two transmission cards in cascade, so LVP615U provides 2 positions for two built-in transmission cards.

If the actual definition of LED display exceeds the maximum output definition of LVP615U, you may divide the whole LED screen into pieces of smaller LED screens, then put them together in Mosaic manner by connecting multiple sets of LVP615U in parallel to integrate the smaller pieces of LED screens into a large LED display.

With frame synchronization technology, LVP615U solves the problems of misplacement and delay of output image existing in ultra-large LED mosaic, being able to provide real-time, clear and fluent display effects.

LVP615U supports multiple units cascading splicing. By this way, smaller pieces of LED screens can be integrated into a large display. For example, if the output definition of LVP615U is set as 1920×1080, and we put 2 sets of LVP605 together horizontally in parallel, it will be able to connect any LED display of up to 3840×1080 pixels.

There are 16 setup options in splicing setup menu, setup options 1-8 is automatic splicing menu, 9-16 is fine adjustment, automatic setup menu is used to input splicing screen's parameters, in fine adjustment menu option adjust parameters for outputting full picture.

	Adjustment options	Descriptions
	E.1 LED total width	The whole width and height of LED screen
	E.2 LED total height	
	E.3 unit width	The LED screen resolution and position
	E.4 unit height	

Automatic splicing menu	E.5 unit horizontal start	compared with the whole splicing screen driven by this unit of LVP615U
	E.6 unit vertical start	
	E.7 sync. splicing	ON or OFF of the sync splicing
	E.8 automatic splicing	Application of automatic splicing parameters
Manual setup menu	E.9 in width	The size and location of DVI input image the current unit crops
	E.10 in height	
	E.11 in H-start	
	E.12 in V-start	
	E.13 out width	Output parameters of LVP615U, it is as same as the menu 1. Output image
	E.14 out height	
	E.15 out H-start	
E.16 out V-start		

Enter adjustment setup: under splicing mode (Mosaic indicator lit up), by pressing “Setup” button, LVP615U enters splicing adjustment setup menu “E. Mosaic”

Return to upper level setup menu: under the mode of adjustment setup, press “↩” button, LVP615U exits adjustment setup.

Note: when use multiple LVP615U cascading splicing, to make sure the output image have uniformity, every unit’s parameters of 4.3 brightness, 4.1 inpu color, 4.2 sharpness and 8.2 bias must be same.

Operation is as below:

When the input signal of LVP615U is DVI format and the splicing mode is open (Mosaic indicator lit up), press Setup, LVP615U enters splicing menu. Press ↓button to select setup option needed to adjust, rotate knob to change parameter, press OK button to save.

Operation is as below :

In the menus E.1~E.2, input parameters of whole splicing screen;

In the menus E.3~E.4, input the size and location (relative to whole splicing screen) of LED screen the LVP615U drives;

In the menu E.7 sync. Mosaic menu, select to turn the function on or off;

LVP615U 使用说明

In the menu **E.8 auto Calculation**, press OK, LVP615U starts to mosaic automatically;

Observing image splicing effect. If any problem, enter fine adjustment menu option **E.9~E.16** to adjust image.

Below is a 2×2 mosaic example using 4 sets of LVP615U, telling us how to use multi-units cascade of LVP615U and what we should pay attention to.

The definition of the LED screen is 3456×1920, we can divide it into the four small pieces of LED of 1728×960 pixels as shown in figure below, each piece of small LED screen is driven by a unit of LVP615U. With total 4 sets of LVP615U, the 3456×1920 pixels LED screen is able to display a full picture.

#1 (1728×960)	#2 (1728×960)
#3 (1728×960)	#4 (1728×960)

Below is the system **topological diagram**:

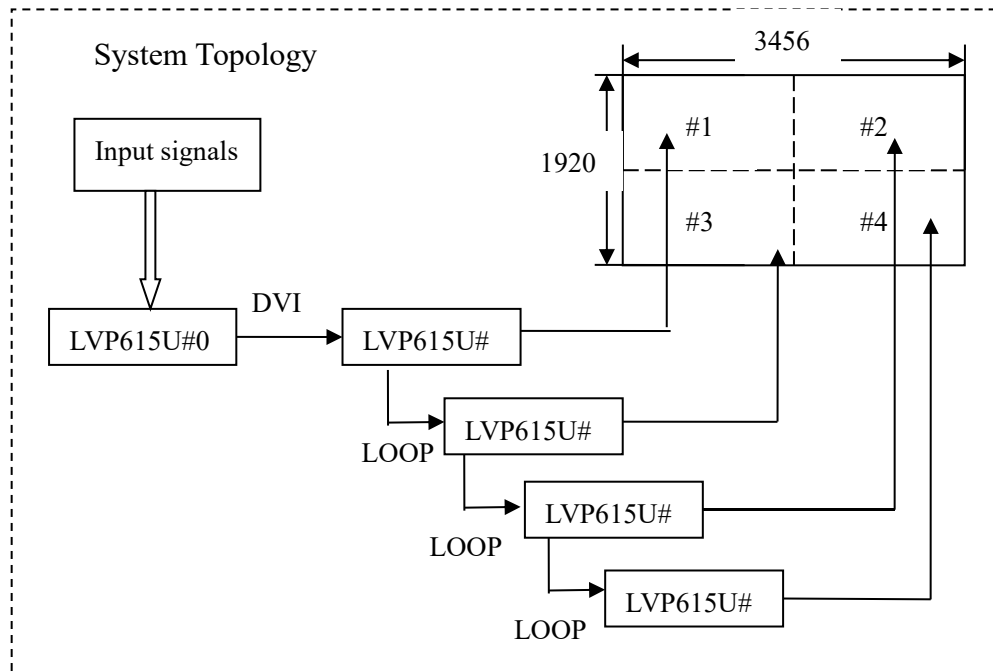

As above diagram shows, all input signals are connected to and switched by **#0 LVP615U**. The 2 same DVI outputs of **#0 LVP615U** are connect to **#1 LVP615U** and **#2 LVP615U**. Then **DVI loop** to **#3** and **#4**.

After that, the output signal of #0 LVP615U is cropped and scale up in #1 LVP615U, #2 LVP615U, #3 LVP615U and #4 LVP615U.

Finally the image that they output will be finally displayed as a whole picture on 4 pieces of LED screens.

The parameters of the 4 units of LVP615U are as below:

Setup options	Parameter setups of processor			
	#1	#2	#3	#4
E.1 LED total width	3456			
E.2 LED total height	1920			
E.4 Unit width	1728	1728	1728	1728
E.5 Unit height	960	960	960	960
E.6 Unit horizontal start	0	1728	0	1728

E.7 Unit vertical start	0	0	960	960
E.8 Synchronization splicing	ON			

In order to ensure all output images are synchronous to each other, please note the following settings:

1. The input signals can be only DVI signals, and if the processor is in mosaic mode, it will be unable to switch input signals;
2. **All the 5 processors must be set the same output resolution.**

Chapter 7 Remote control instructions

LVP615U opens RS232 control protocol supporting PC, Android or IOS intelligent remote control terminal. Here we instruct the hardware connection and software operation as below.

7.1 Hardware communication

LVP615U remote control ports include RS232, USB, Wired network and Wifi control. As below we illustrate hardware communication connection and setup respectively.

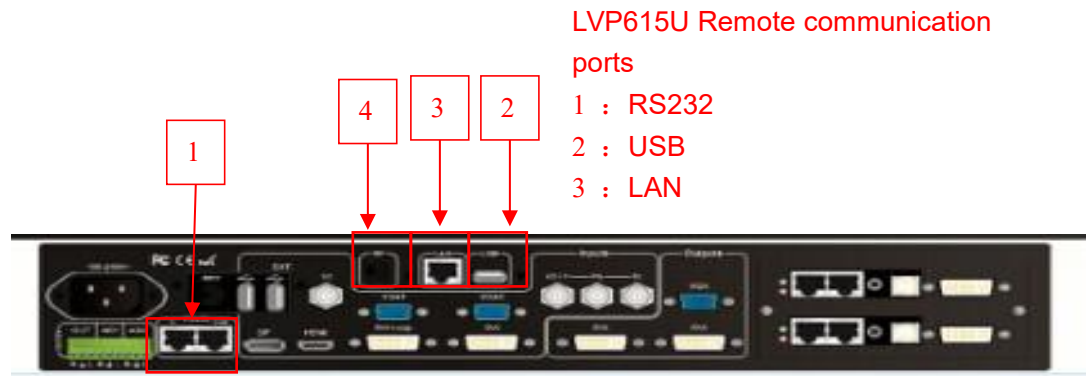

7.1.1 RS232 and USB

RS232 is common port for remote control. When use RS232 control, we only need to use an RS232 cable to connect PC to processor's RS232 port, then we can use software to remote control processor. When PC does not have RS232 port, USB control method can be used.

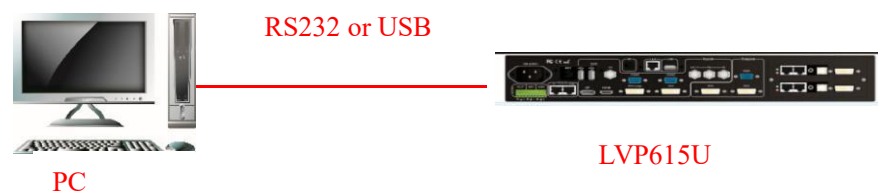

7.1.2 Wired network

LVP615U built-in network convert RS232 module, after wired network connecting LAN and setting relative network configuration parameters (refer user manual page 38 “6. Communication”), LVP615U has been a work station in the local area network. So another terminal device in the local area network can control the LVP615U through software. As the picture below, through software, anyone of terminal (work station) in the local area network can control the LVP615U in the local area network by remote method.

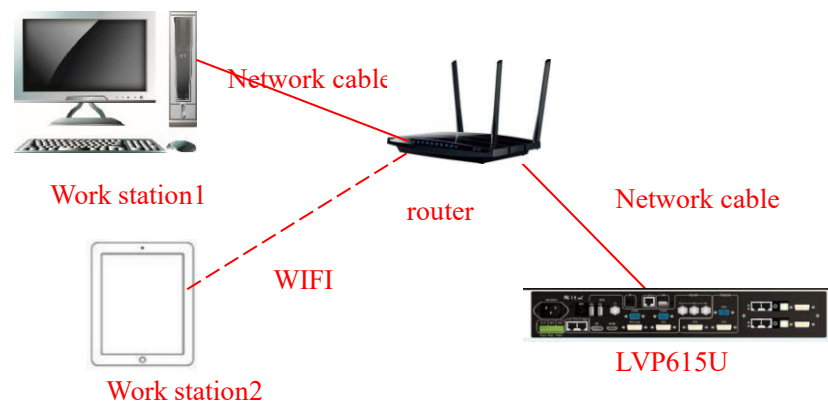

7.1.3 WIFI connection

LVP615U is built in WIFI module. Through this module, user can achieve WIFI remote control of LVP615U. The module supports 2 WIFI connection methods: First., Wireless Router, another wireless device connects the module directly and control.

Second, Through WIFI connect wireless Router and become a work station in the local area network, so another terminal device in the local area network through software to control LVP615U by remote method, the control method is similar through LAN port connecting.

Here are relative setup and instruction about LVP615U WIFI module and how to realize the 2 control methods.

NOTICE: When using WIFI connection, WIFI ANTENNA must be installed.

7.1.3 WIFI connection

Using laptop with wireless network, open network and share center, search and connect the wireless network named LVP615U, the default WIFI password is 88888888

Configuring network be automatically obtain IP address and DNS server address, show as the picture below:



Configuring network be automatically obtain IP address and DNS server address, show as the picture below:

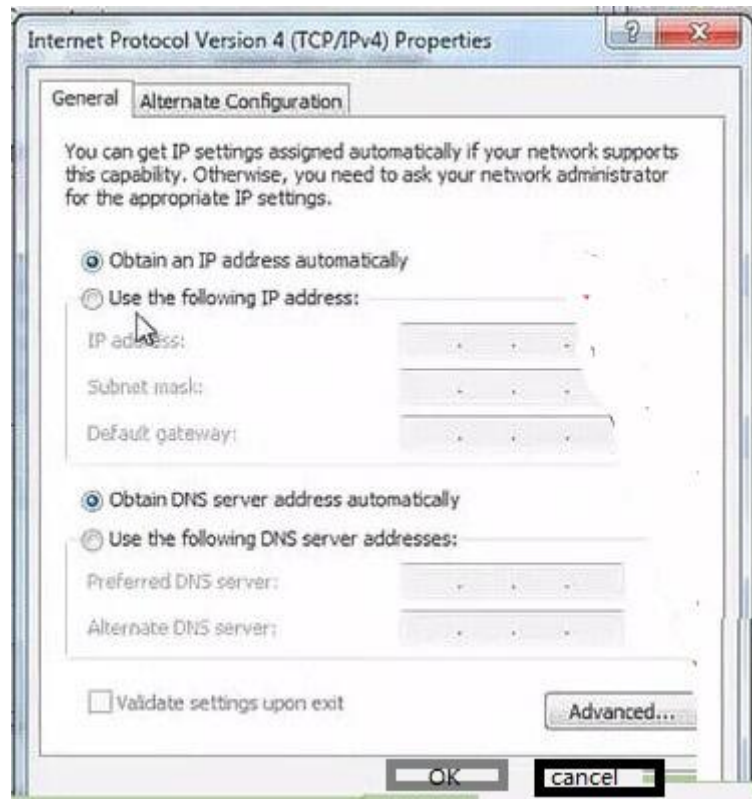

Note: if can't connect, entering setup menu "8.7Wifi reset" to reset WIFI module (refer user manual page 48), then restart and connect.

7.1.4 Wireless Module Configuration

- 1) Running wireless scan configuration software "LVP615U WIFI Config Tool.exe", the application software is as below.

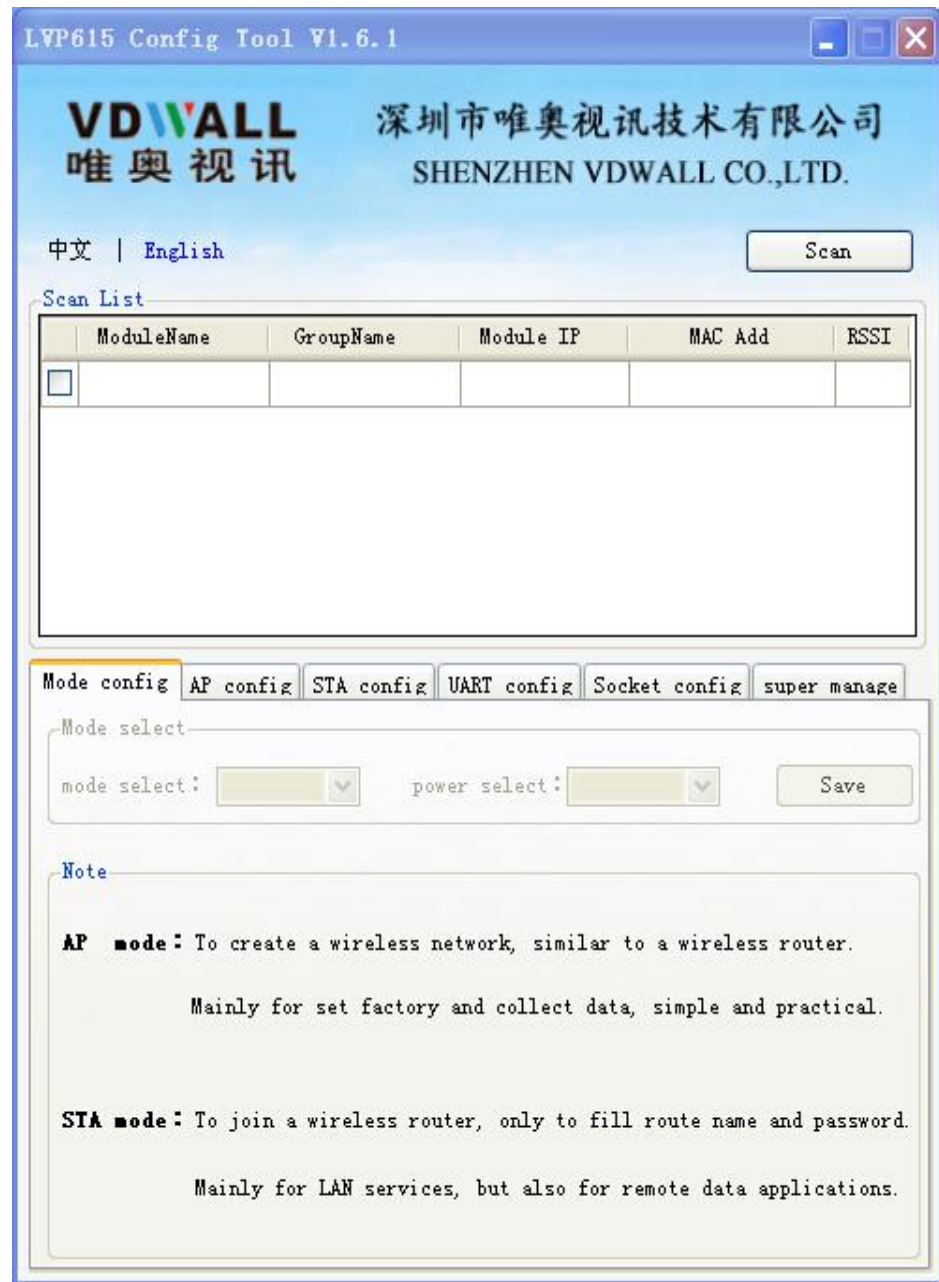

2) Click “Scan” to search LVP615U in the local area network, after searching module the information display as below.

scan_list					
	ModuleName	GroupName	Module IP	MAC Add	RSSI
<input checked="" type="checkbox"/>	LVP615	LVP615	192.168.7.1	60:C5:A8:66:18:42	-0
<input type="checkbox"/>					

(3) In scan list click relative WIFI module, when appear dialog box, type in user name (default name is **admin**) and password (default password is **admin**), software will remind “module identify successfully” and “obtain configuration parameter successfully”, meanwhile software interface will display relative information.



(4) Now you can configure module. Configuration options include Mode Setting, AP Setting, STA Setting, Serial Port Parameter Setting, Socket Setting and Advanced setup. See the configuration method step by step below:

Notice: after configuring every step, you need to click save button to save configuration parameter. All modified parameters will be valid after module restarting.

a. Mode Setting

This step mainly sets the Mode and Consumption Level of module.



The screenshot shows a configuration window with two dropdown menus and a save button. The first dropdown menu is labeled 'mode selection' and has 'AP' selected. The second dropdown menu is labeled 'power-level' and has 'Full' selected. A 'save' button is located to the right of the second dropdown menu.

Normally we set the consumption being “Full”, mode description as the table below. Select the level according to your need. After modifying configuration click “save” button to save.

Work Mode	Description
AP	Establish a encrypted wireless network, similar to a wireless router. Mainly used to reset module, or control WIFI in the status of no local area network. (Recommended)
STA	Make the LVP615U as a work station, configure and join a wireless network. It can be realized by typing in router name and password.

b. AP Setting and STA Setting

After selecting the mode, we need to configure specific parameters for the mode. See as below:

Mode config AP config STA config UART config Socket config super manage

AP configure

wireless SSID: LVP615_AP channel select: 2452MHz (channel 9) ▼

SSID broadcast ▼ IP address: 192.168.7.1

Encrypt select WPA2-PSK ▼ subnet mask: 255.255.255.0

wireless PSK: 88888888 DHCP service: Open (Default)

Save

AP setting

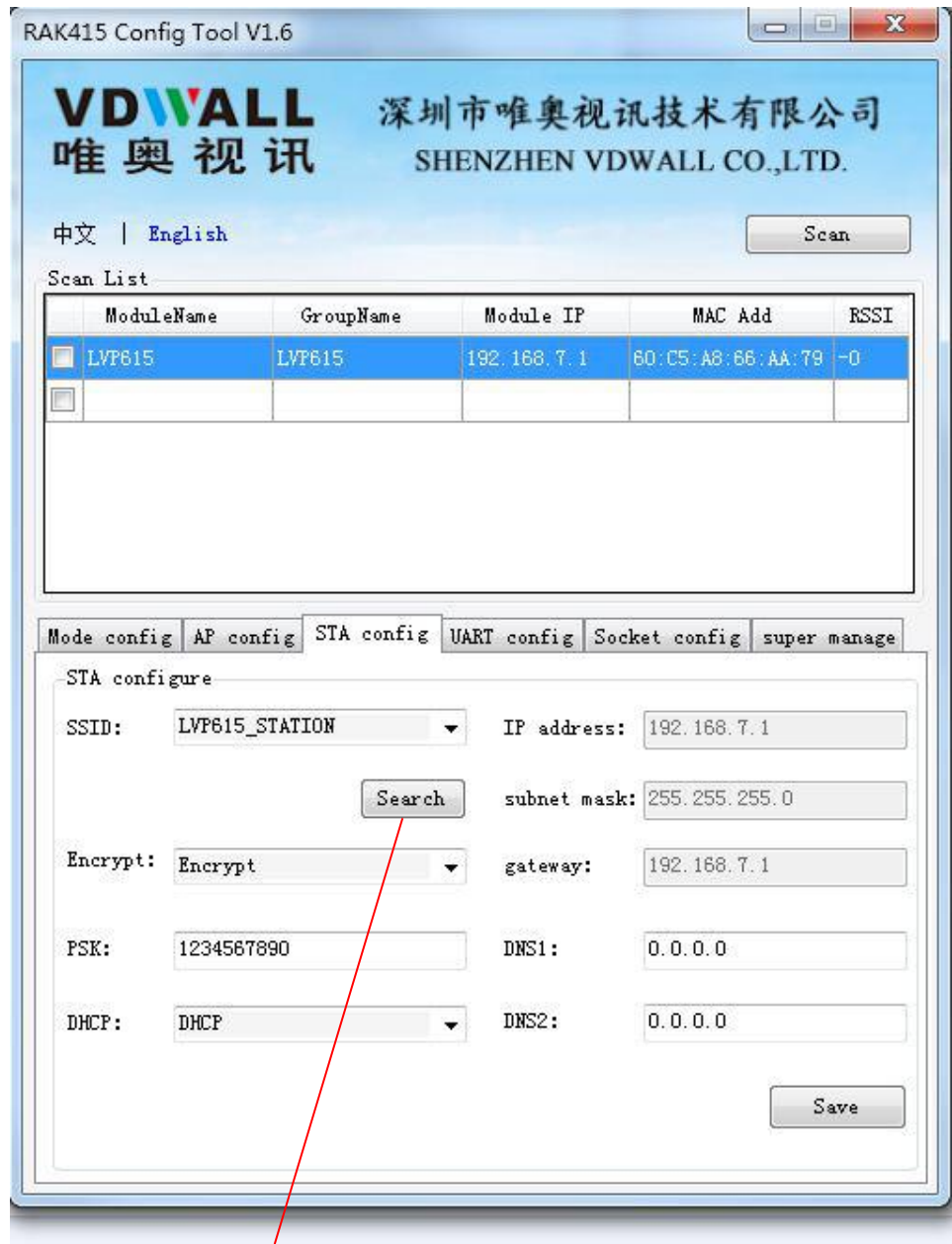

Click search key to find the around wireless network.

STA setting

Notice: Better use manual method instead of automatic method to avoid disconnection due to IP address changes.

c. Serial Port Parameter Setting

This step is for setting basic parameters of serial port, after modifying configuration, click “save” button to save change. As the picture below shows, the boardrate should be 9600.

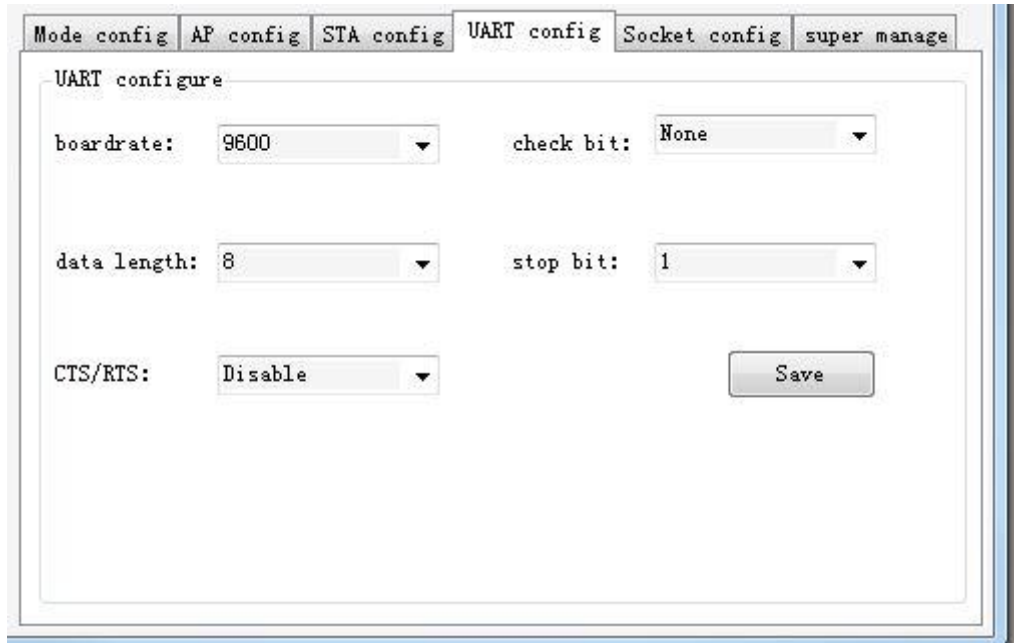

d. Socket Setting

This step is for Setting basic parameter of Socket. Single or Double Socket are supported, After setting configuration, click “Save” button to save. Please notice that the local port number of Socket A should be same when configuring the PC software.

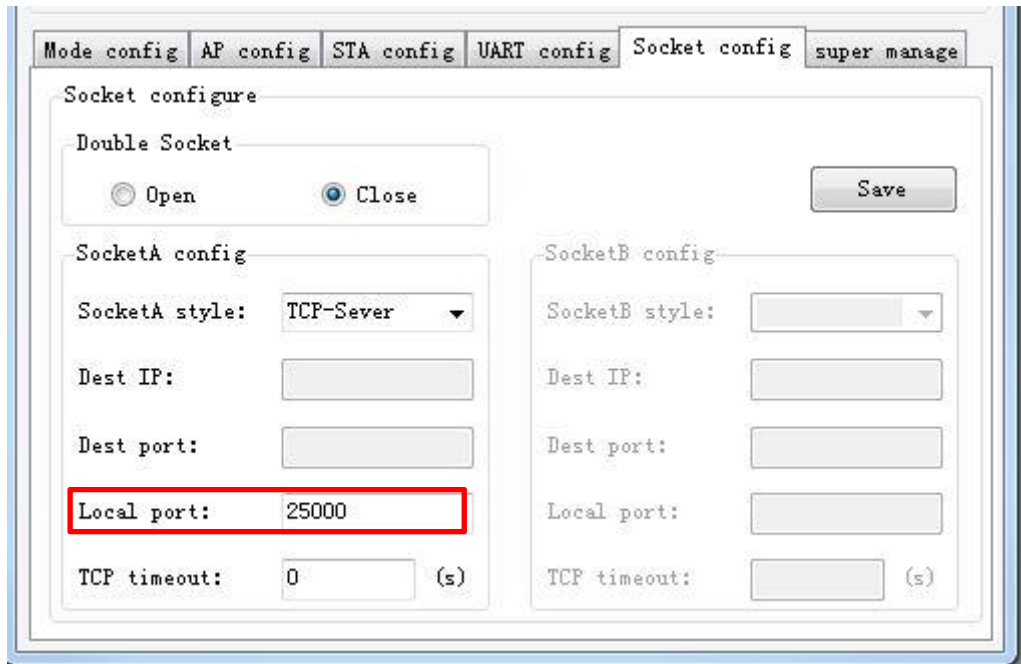

E. A super manage

Super manage includes modifying user name and password of module (Identification information), name and group name of module, reset module and reset to default, Please set according to needs. See the picture below:

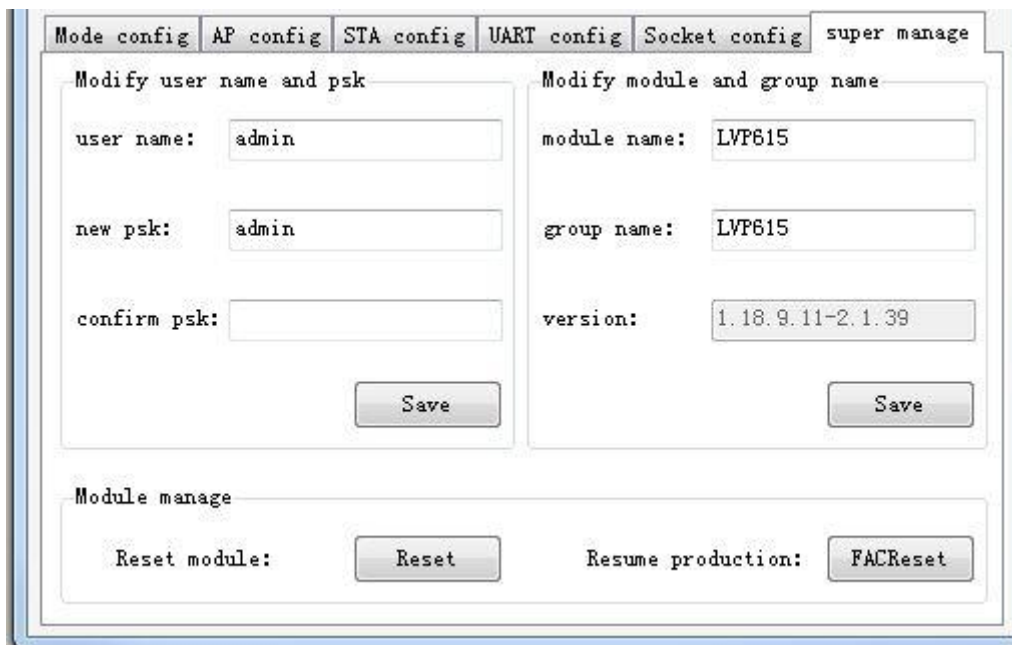

7.2 PC control software instructions

LVP615U's control software used to control LED HD video processor LVP615U. Through the software, we can realize:

- Selecting input signal switch by seamless switching or fade in fade out mode
- 3 user defined modes of double picture display or test overlay
- Turn on or off Bypass, Freeze and Mosaic functions
- Specific parameters of LVP615U setting
- Timing control function: set time for switching or select input signals
- Multi units cascading splicing function

7.2.1 Control method

As illustrated above, the PC remote control of LVP615U can realize connection by RS232, USB, LAN or WIFI. After connecting and needed configuration, we can run the control software: “LVP615U Control Software.exe”

1、 Introduction of Software Interface

Double click the software, the software interface shows as below:

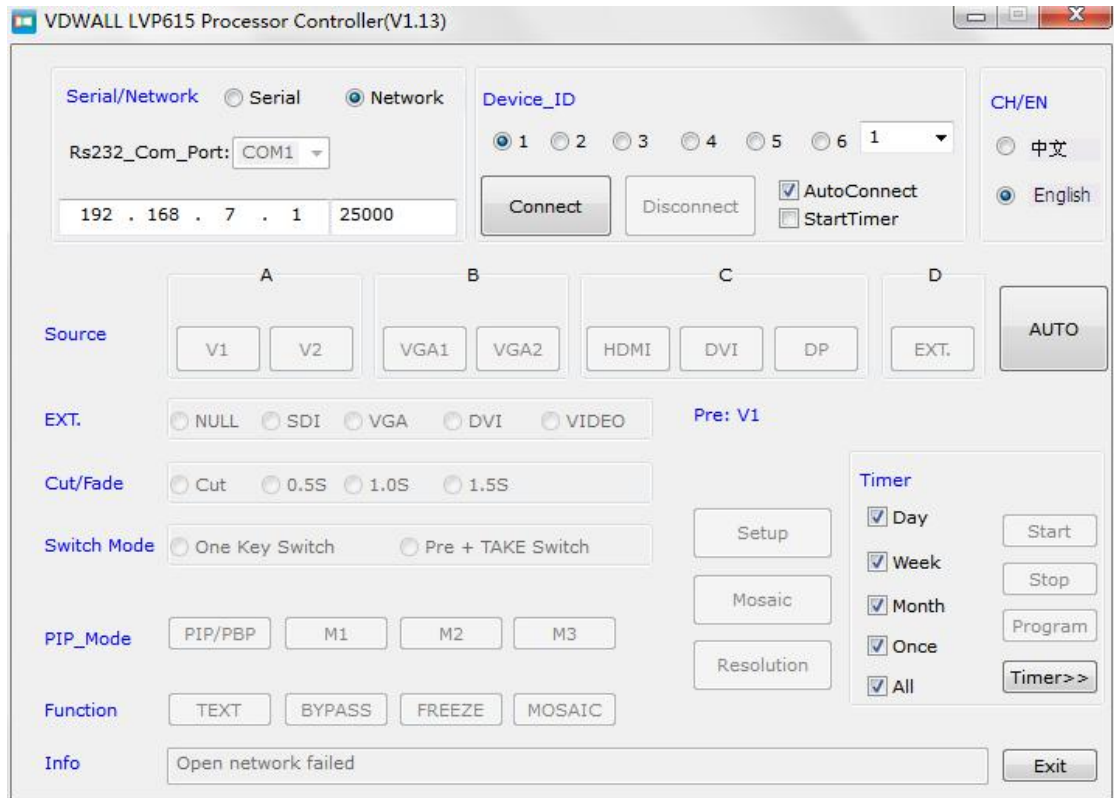

As shown above, there are 9 main parts of the software:

- 1) Communication Setting
- 2) Language Setting
- 3) Signal Switch
- 4) Function and Mode Selection
- 5) Information
- 6) Timing Control Setting
- 7) Output Parameters Setting(Screen Setting)
- 8) Multi Units Cascading Splicing Setting(Quick Mosaic)
- 9) Output Resolution Setting

1) Communication Setup



In communication setup, first select connection method being Serial or network.

If select serial, need to select correct COM port. COM port number can be checked in PC's "device manager", show as the picture below:

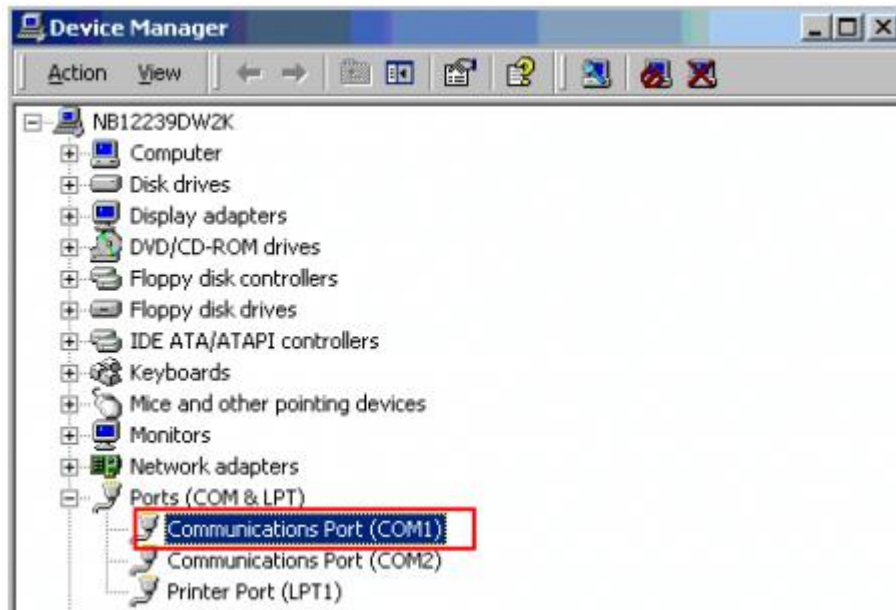

The device ID number you select must be as same as the LVP615U's which you need to controlled.

If select network connection, firstly must set the network connected being correct, the relative setup about wired network prefer 6. Communication (user manual page 46), wireless network setup refer user manual page 53. In IP address and port number option type in correct setup, the default setup of wired network and wifi AP mode refer the table as below.

connection	Default IP address	Default port
LAN	192.168.1.8	7
WIFI	192.168.7.1	25000

Click "connect" button, the software shows



After the device connecting successfully, every function button in software inter face has been activated. Information area on main interface displays reminder connecting successfully.

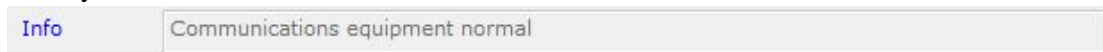

Setting timer automatically start: to select whether the processor automatically connect serial port and automatically open the timing control in next starting up.

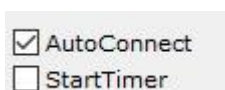

2) Language setup



Software interface displays language selection, and the software supports two languages Chinese and English.

(3)Signal select

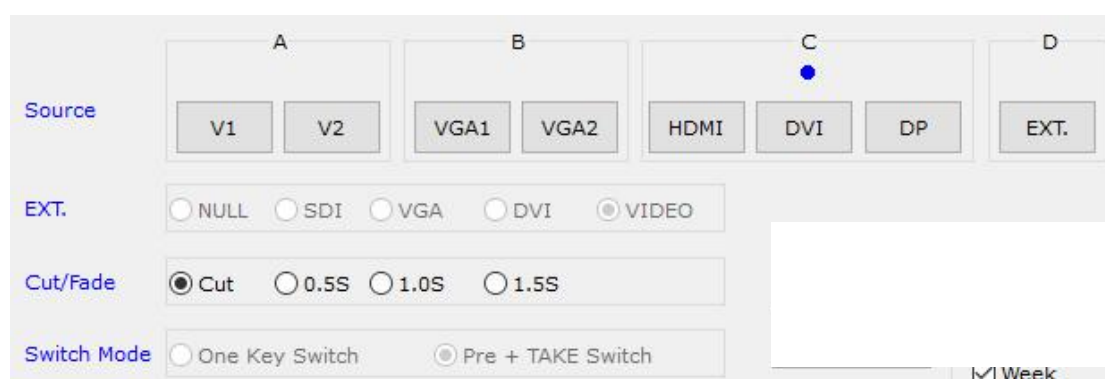

The buttons of the signal area respectively represent the corresponding keys and status indicators in the panel of the processor.

After the device is successfully connected, the software will read the input signal source you currently selected and the blue indicator above it will turn on. If the blue indicator illuminates normally, it means the input signal source you currently selected is valid;

LVP615U 使用说明

however, if the blue indicator blinks, it means there are no valid signal input.

AUTO: VGA automatically adjust button, only available for VGA1, VGA2 and EXT.VGA.

Switching effect selection, can select cut (seamless switching) and fade in / fade out (0.5s 1s 1.5s) switching.

Switching mode:

Default switching mode is **one key switch**, this moment press signal button, switch input to relative signal;

If select pre + **TAKE** switching, the signal area become the style as below,

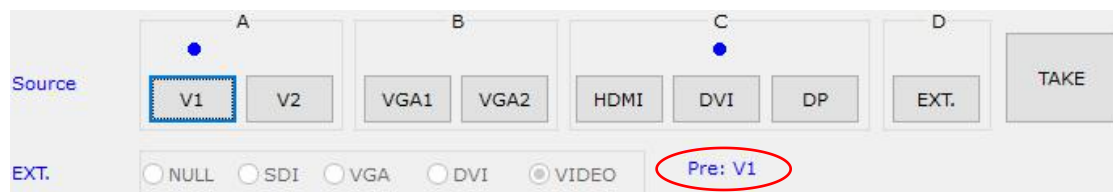

4) function and mode setup

The buttons in this area used for PIP, TEXT (Text Overlay), BYPASS, FREEZE, MOSAIC

PIP/PBP: PIP switch, used to open or close PIP mode, meanwhile the bright point above the button indicates the mode open or not.

M1、**M2**、**M3**: PIP mode buttons, the blue bright point above the mode button shows which mode you have selected.

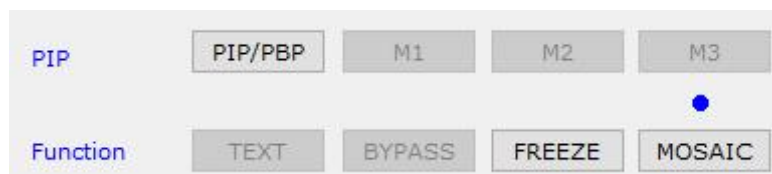

TEXT: text overlay display switch, used open or close text overlay function; meanwhile the bright point above the button indicates the function is open or not.

BYPASS: full and part display switch button, only available for PC signal VAG DVI HDMI DP.

Freeze: Image freeze switch button, it is available when under signal switch mode.

5) Information column

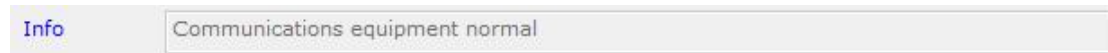

If operation is unsuccessful, the information area will display the reason of failing.

6) Timing control setup

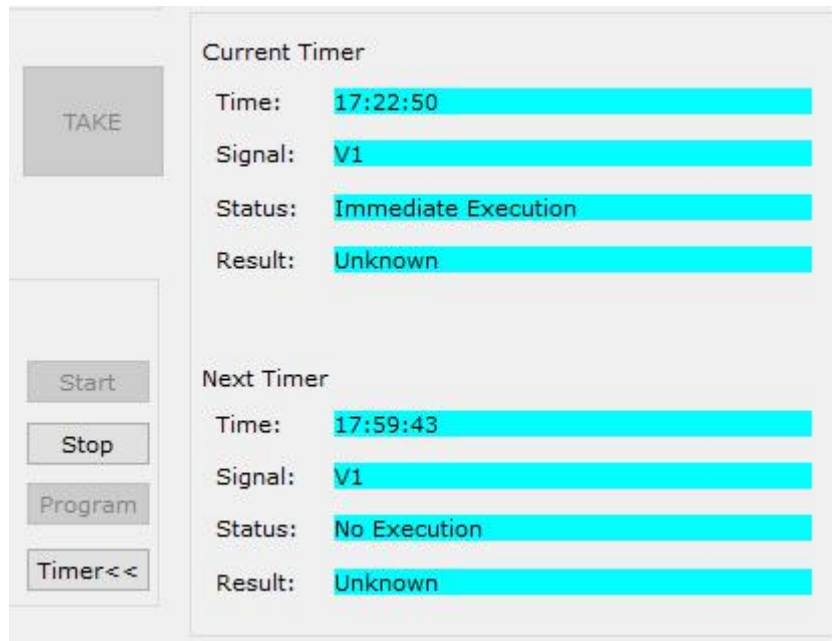

The Timer of the Control Software can switch the input signal source of LVP615U as per the preset timer plan. The system provides four cycle timer modes, i.e.: Day, Week, Month, Once.

Start timing: Start: open timing control function

Stop timing: stop timing control function

Timer<<: spread or shrink timing execution list on right side.

Click "Program" to enter timer setup menu, where you can view the timer plan you already set, or add, modify, delete timer plans.

Setting timing parameter

In user interface click Program, appear setup interface of timer, show as the picture below:

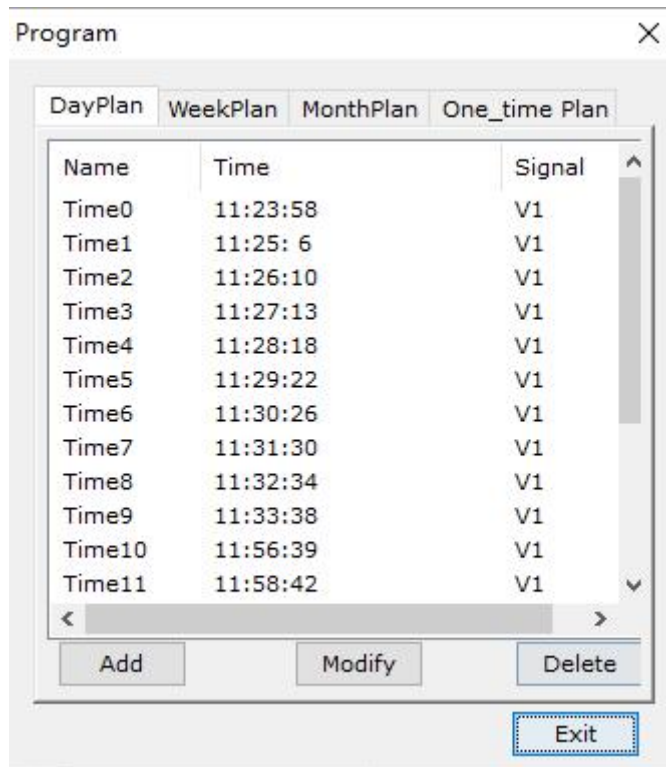

Show as the picture above, there are two types of plan:

- (1) Cycle Plan
- (2) Once plan

Cycle Plan is sub-divided into three types:

- (1) Day plan (timing in one day)
- (2) Weekly plan (timing in one week)
- (3) Monthly plan (timing in one month)

User can select one type he desires

The plan items of Day Plan define hours, minutes, seconds;

Each week has 7 days, so the plan items of Week Plan define week day, hour, minute, second;

LVP615U 使用说明

Each month has maximum 31 days, so the plan items of Month Plan define date, hours, minutes, seconds;

The plan items of Once Plan define year, date, hours, minutes, seconds;

Cycle plan and once plan can work together.

For each type of plan, the plan items can be added, modified, deleted.

For example, the figure below shows how to add plan items to a day. Plan

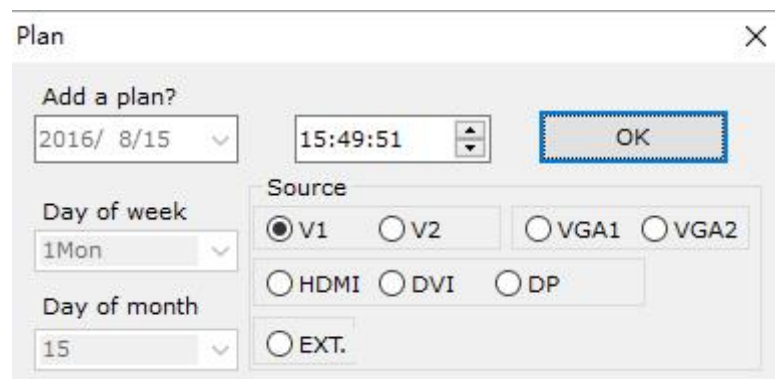

The screenshot shows a dialog box titled "Plan" with a close button (X) in the top right corner. The dialog is divided into several sections:

- Add a plan?**: A date dropdown menu showing "2016/ 8/15" and a time spinner control showing "15:49:51". An "OK" button is highlighted with a blue dashed border.
- Day of week**: A dropdown menu showing "1Mon".
- Day of month**: A dropdown menu showing "15".
- Source**: A group of radio buttons for selecting a source:
 - V1
 - V2
 - VGA1
 - VGA2
 - HDMI
 - DVI
 - DP
 - EXT.

Select the plan already added, then you can modify or delete it.

7) Output date setup

In user main interface click **Setup**, appearing the setup interface of output parameter, in the interface user can set output parameters of processor.

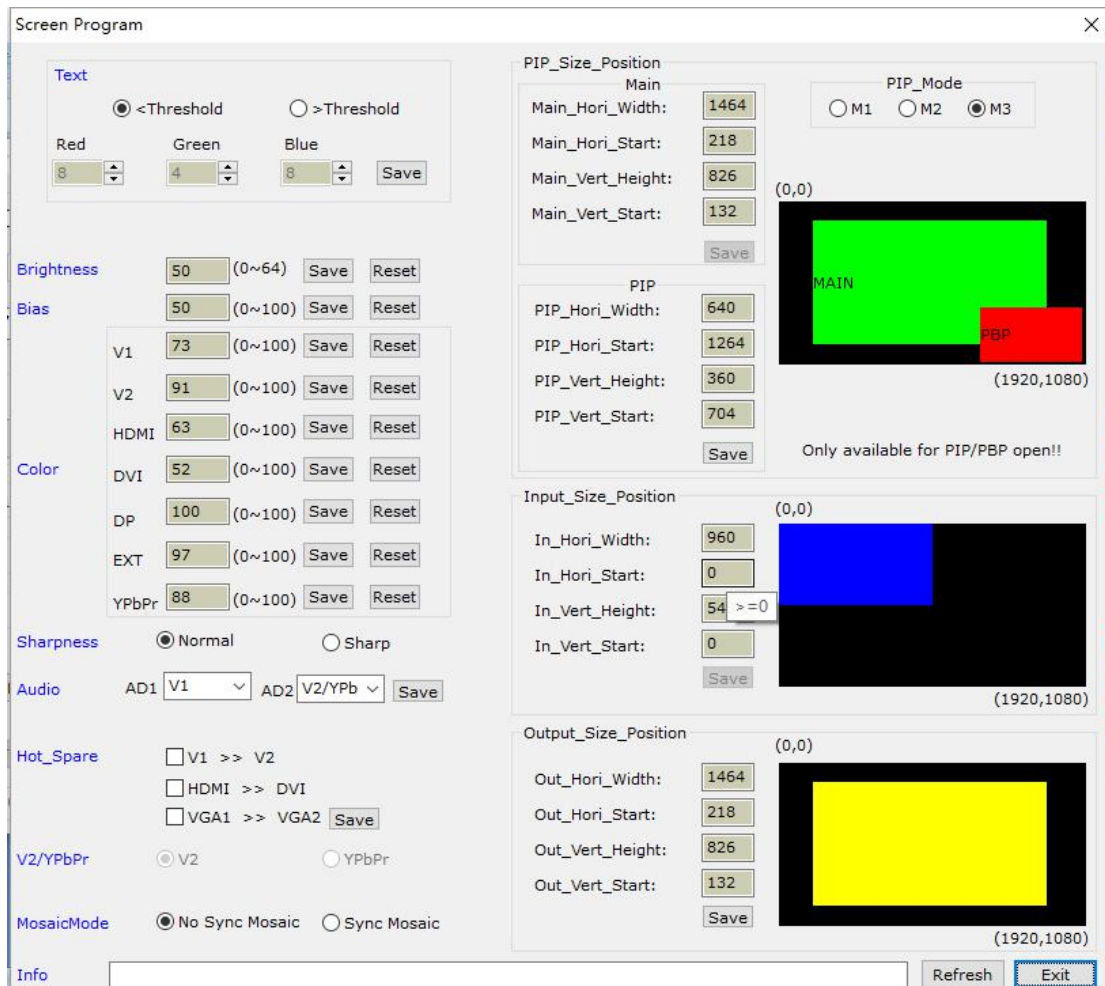

As shown in above figure, the button “Refresh” is used to update the information of currently processing parameters after parameters configuration is finished. Any abnormal of parameter will be reminded in info field.



The setting parameter in interface has zury background indicates the parameter is typing in or aren't saved, grey background indicates the parameter has been saved.

Out_Hori_Width:	<input type="text" value="144"/>
Out_Hori_Start:	<input type="text" value="218"/>

Show as the picture

Screen output parameters include these parts as below:

(1) Image input/output parameters configuration and mosaic mode setup

The parameters of output windows should be configured to the actual pixels of the screen to be driven.

Mosaic mode setup and input image parameters configuration apply to multi-machine parallel mosaic only. The mosaic options are provided to set whether the processor adopts synchronous or non-synchronous mosaic mode. Input image parameters are used to set the location and size of the images to be captured from input image based on the actual size of the screen.

Caution: input image parameters shall not be configured unless the following conditions are met:

- a. The input signal of the processor is DVI
- b. The resolution of DVI input signals is the same with output resolution of the processor.
- c. The processor is in mosaic state(the mosaic indicator illuminates normally).

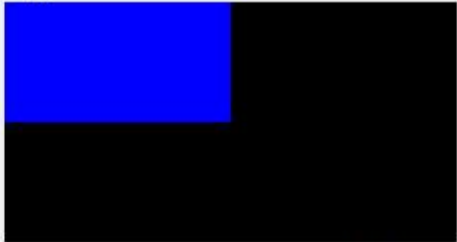
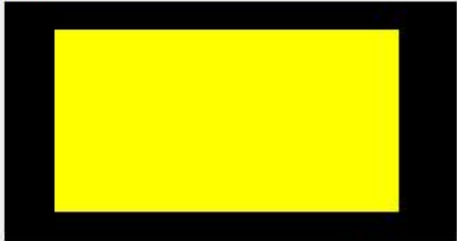
Input_Size_Position		(0,0)
In_Hori_Width:	<input type="text" value="960"/>	
In_Hori_Start:	<input type="text" value="0"/>	
In_Vert_Height:	<input type="text" value="540"/>	
In_Vert_Start:	<input type="text" value="0"/>	
	<input type="button" value="Save"/>	(1920,1080)
Output_Size_Position		(0,0)
Out_Hori_Width:	<input type="text" value="144"/>	
Out_Hori_Start:	<input type="text" value="218"/>	
Out_Vert_Height:	<input type="text" value="826"/>	
Out_Vert_Start:	<input type="text" value="132"/>	
	<input type="button" value="Save"/>	(1920,1080)

(2) PIP/PBP display setup (location and size of PIP windows)

This menu is used to set the three PIP/POP display modes of LVP605, first, select a PIP mode to be adjusted, then enter the parameters of background, location and size of PIP windows, then click "Save" button to save the parameters in the processor.

PIP_Size_Position

Main

Main_Hori_Width: 1464

Main_Hori_Start: 218

Main_Vert_Height: 826

Main_Vert_Start: 132

Save

PIP_Mode

M1 M2 M3

(0,0)

MAIN

PBP

(1920,1080)

Save

Only available for PIP/PBP open!!

(3) TEXT setup

It is used to set the red, green and blue threshold values of valid information of the text signals to be captured by the processor, also to set whether the text is greater or less than threshold values, select appropriate threshold values, click "Save" button to save them in the processor.

Text

<Threshold >Threshold

Red: 8

Green: 4

Blue: 8

Save

(4) Brightness, color, bias, sharpness setup

These options are used to set brightness, color, bias and sharpness of output image, after typing in desired parameter click **save** button to save, or click **reset** button to reset parameters being default value. Directly click “Normal” or “Sharp”, the parameters will be saved.

Notes: the default values of brightness, color, bias are all 50.

Brightness	50	(0~64)	Save	Reset	
Bias	50	(0~100)	Save	Reset	
Color	V1	73	(0~100)	Save	Reset
	V2	91	(0~100)	Save	Reset
	HDMI	63	(0~100)	Save	Reset
	DVI	52	(0~100)	Save	Reset
	DP	100	(0~100)	Save	Reset
	EXT	97	(0~100)	Save	Reset
	YPbPr	88	(0~100)	Save	Reset
Sharpness	<input checked="" type="radio"/> Normal <input type="radio"/> Sharp				

Configuring audio

This option is used to set AD1, AD2 audio port as the corresponding video input port, so as to realize synchronous switching of audio/video signals.

Audio	AD1	V1	AD2	V2/YPb	Save
-------	-----	----	-----	--------	------

Hot spare setup

This option is used to turn on/off the hot spare function of the following four groups of input signals.

Hot_Spare	<input type="checkbox"/> V1 >> V2	
	<input type="checkbox"/> HDMI >> DVI	
	<input type="checkbox"/> VGA1 >> VGA2	Save

V2 or YPbPr Setting

You can select this terminal as V2 or YPbPr.

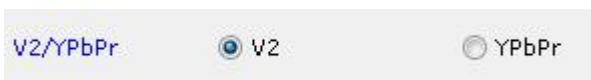

8) Multi units cascading splicing rapid setup

LVP615U can drive ultra high-definition LED display through multi-machine cascade mosaic. User can complete input/output parameters configurations setup of each processor through fast mosaic menu.

In this menu, user only need select mosaic mode (namely how a large is divided into a number of smaller pieces of LED) and the actual pixels of each LED driven by each set of processor, the program will automatically calculate the mosaic parameters of each set of processor and save them in the corresponding processor.

Enter Fast Mosaic Menu: after entering main menu of LVP615U, click “rapid splicing”, the menu as below will pop up.

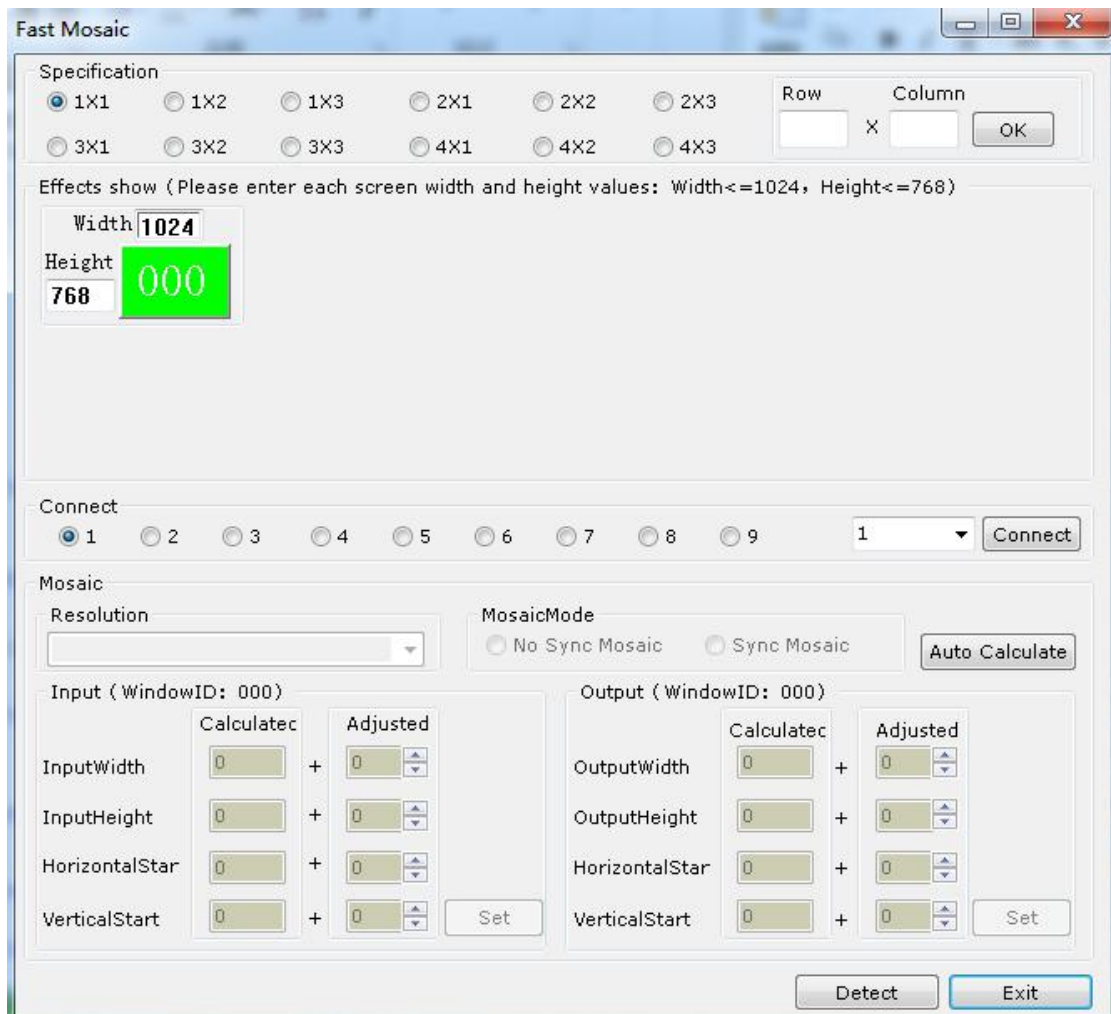

Caution: before making the mosaic settings, please make sure the following conditions have been met:

- (1) All processors are the same with each other in brightness, color, contrast and definition.
- (2) All processors must use the same output resolution, and make sure it the same with that of input DVI signals.
- (3) The current input source of all processors is DVI signals, and make sure the Mosaic function is enabled (Mosaic indicator illuminates normally).

The detail step of mosaic: Before performing mosaic setup, make sure that each LED display and processor are working well, and that each LED display is able to display

a full picture independently. Connect all the processors or the first processor to be adjusted via serial ports.

(1) Using software connect processors

Select the device ID of the first processor to be adjusted (from user setup item 6.5 “Device ID”), click “Connect”, the processor will automatically connect the processor, the software will read and display the current parameters (e.g.: output resolution) of the processor.

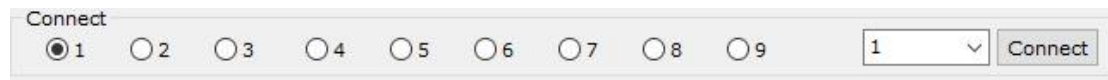

(2) Select mosaic mode

Select current mosaic mode in “Specification” field, namely set how many rows and columns the divided pieces of smaller LED will be arranged. User can also manually enter the number of rows and columns then click “OK”. For the LED of 3648x2016 pixels, it should select 2x2 mosaic mode.



(3) Enter actual parameters of each LED

After select mosaic mode, the result show column will show the actual LED screen layout. Input the height and width of each led screen. Like the following picture:

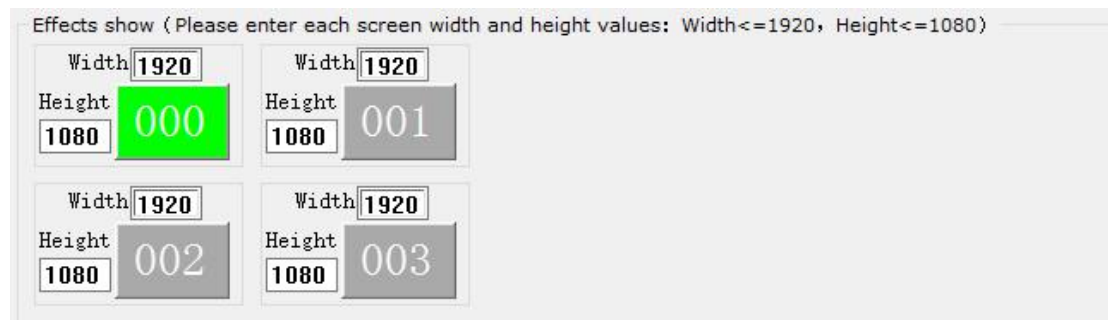

(4) Parameters configurations of the first processor

Select the No. of the LED for showing effect in the field “Effects show” (we select the first LED **000**), click “Auto calculate”, the processor will automatically calculate the due parameter values of current processor based on the parameters entered in “Effects show”. Select the Mosaic mode you desire, and select Sync Mosaic for the LED, the software will

LVP615U 使用说明

pop up the message "Configuration is successful". Click "Set" button respectively in input and output field, the software will automatically save the parameters that it worked out in current processor.

Caution: both input and output parameters of LVP615U must be even, but the results of auto calculation may be odd, if so, it is necessary to set an adjusted value to correct the parameters to be even, then you can click "Set" to save it.

Input (WindowID: 000)		Output (WindowID: 000)			
	Calculatec	Adjusted		Calculatec	Adjusted
InputWidth	960	0	OutputWidth	1920	0
InputHeight	540	0	OutputHeight	1080	0
HorizontalStar	0	0	HorizontalStar	0	0
VerticalStart	0	0	VerticalStart	0	0

(5)Parameters configuration of other processors.

Connect other processors to be set in turn using RS232 cable, select device ID, select No. of corresponding LED following above step 4), the system automatically calculates the parameters of the processor, then select Mosaic mode. Complete parameters configurations of other processors in this way.

Output resolution setting

Resolution

Output_Resolution

1920x1080@60Hz

Width

Height

Hz Hz Save

OK

At the main interface of LVP615U control software, Click **Resolution**. And then the above interface will appear. In this interface, the user can set the output resolution.

Setting output resolution: click downward triangle to select a proper output resolution, processor will apply the resolution selected automatically. If select custom resolution, you need to set the width, height and frame, after configuring click **OK** to apply the resolution.

(一) Using APP for remote control

LVP615U supports to be controlled by mobile device for example tablet computer and mobile phone. User can download the APP and install. IOS platform can download and install the APP by link: <https://itunes.apple.com/cn/app/LVP615U/id1129709980?mt=8> or by scan the two-dimension code below. Below we illustrate the remote control about using IOS platform's LVP615U control APP.



1、 Connection

Firstly, through local area network (LAN interface) or WIFI connect LVP615U and mobile device installed APP. In here we illustrate by using router function of LVP615U'S wifi module. Open wireless LAN switch of IOS device, in the network searched out, connect the WIFI hot point named LVP615U, the default password is 88888888.

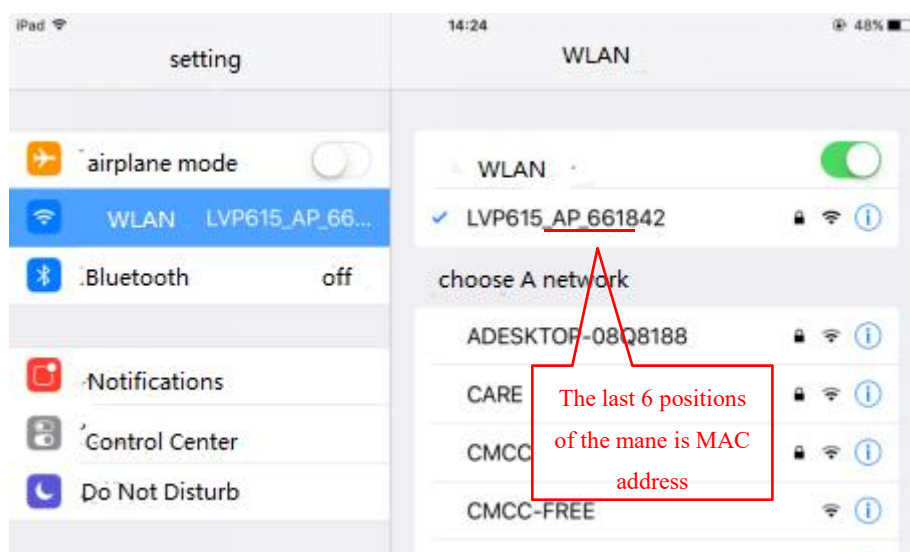

Then open LVP615U control APP to enter guide interface, show as the picture below.

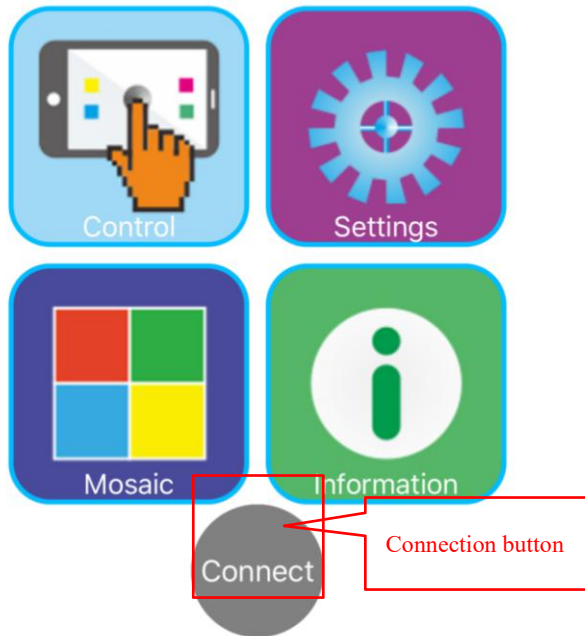

Click **connect**. If the communication is normal, this button's color will change into green from gray.



If connect unsuccessfully, click communication option in adjustment setup, to make sure the setup is correct or not.

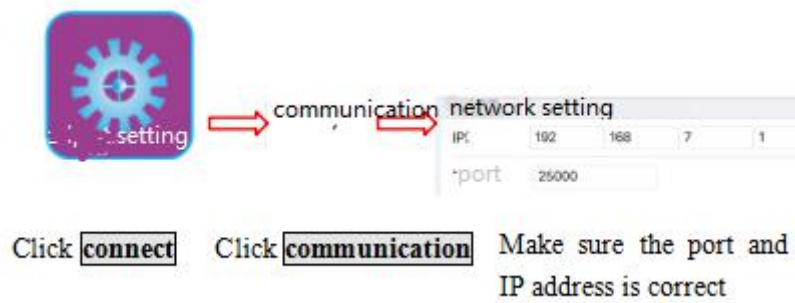

2、 APP Operation

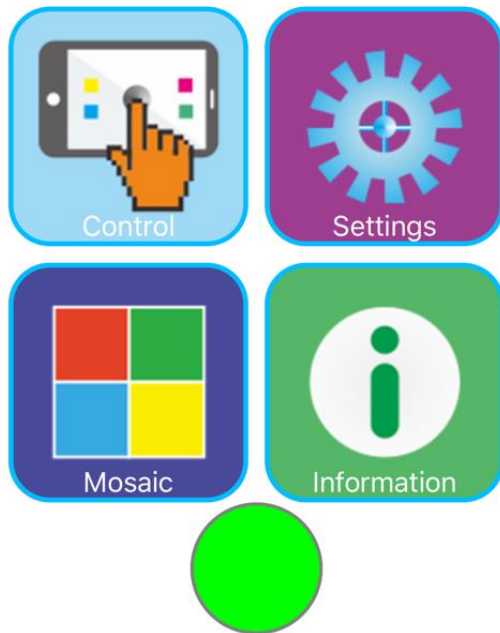

After connection is successful, through software, users can control LVP615U, displaying as the guide interface above, APP has four function areas: operation control, setting, Mosaic setting and information. Single click guide interface, the corresponding buttons will enter selected function interface. We illustrate the four function areas respectively as below.

1) Operation and Control

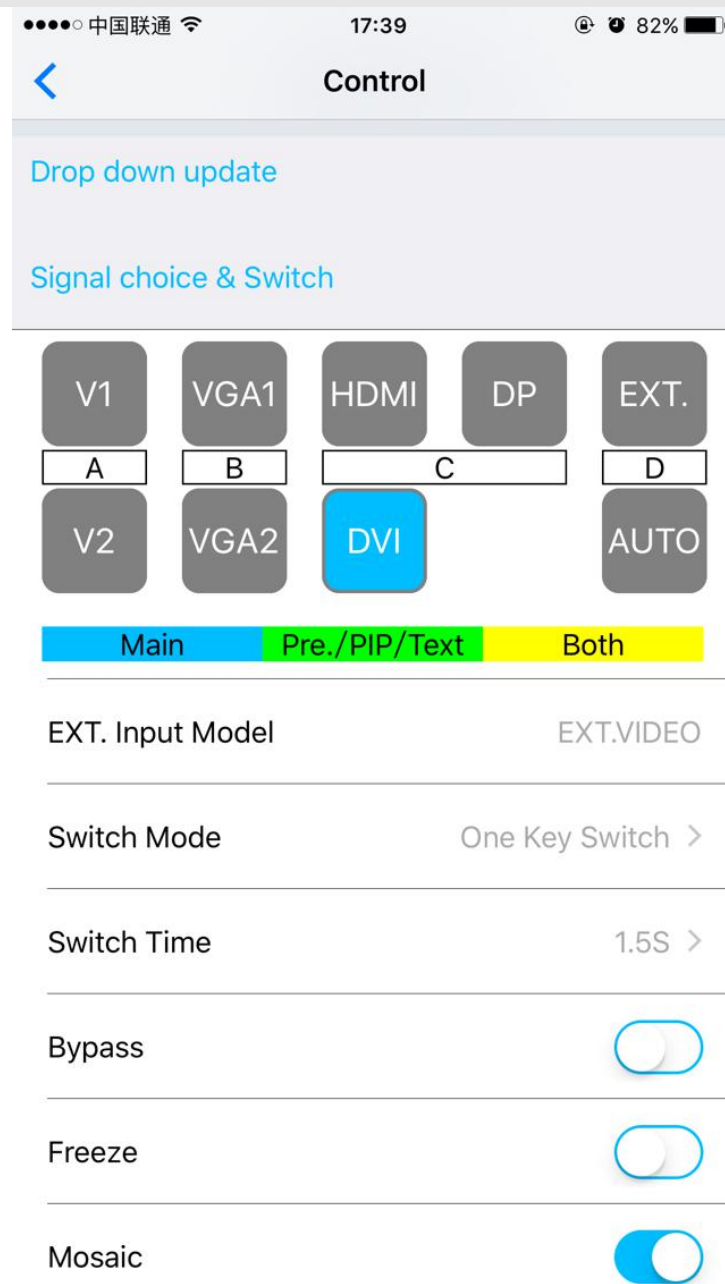

The main functions of operation control interface include: signal switch, PIP/PBP, Text overlay and other functions.

(1) Signal Selection&Switch

LVP615U could support **one key switch** and **Preselect+Take Switch**.

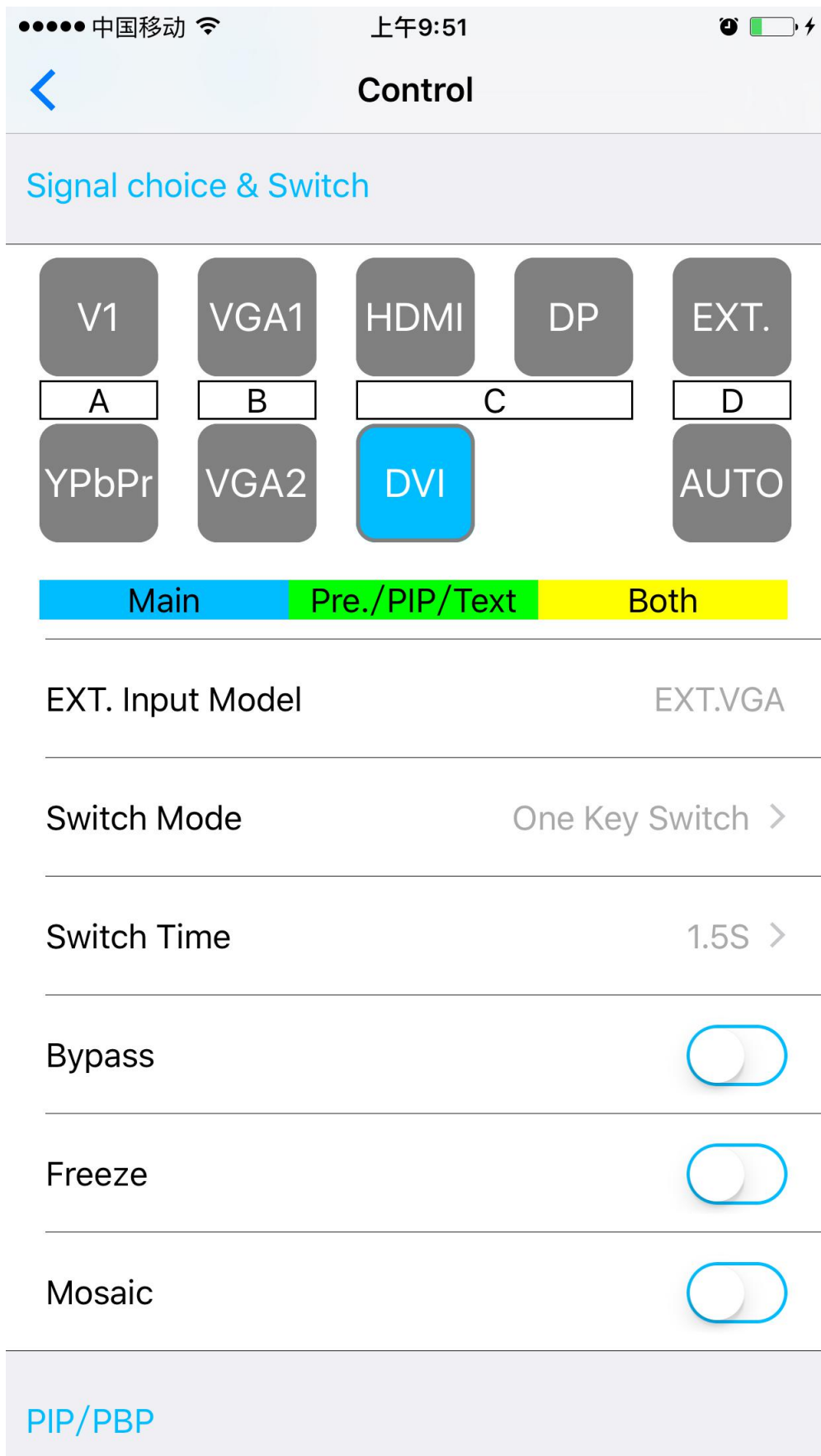

Signal Switching Mode Selection

In operation interface click signal switch mode, pop the interface as below, click to select appropriate switch mode.

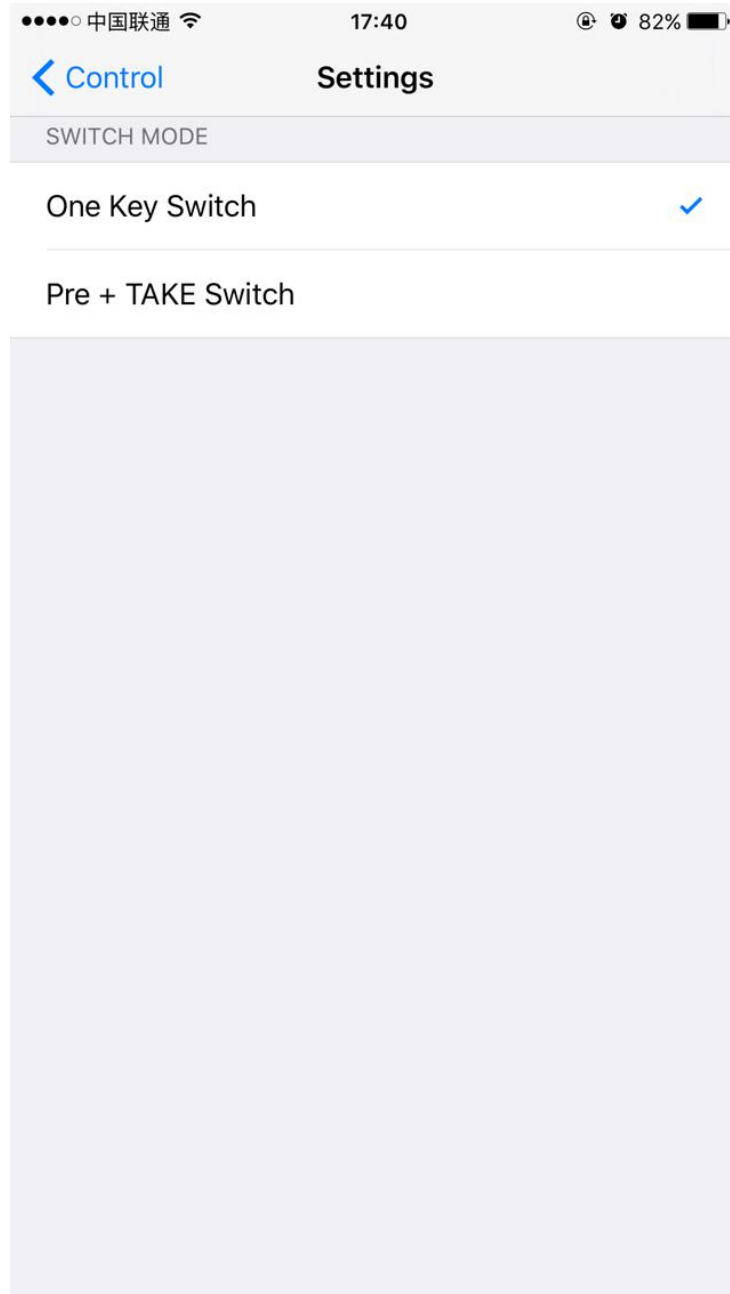

Switching Time Selection

In operation interface, click switching time, popping the interface as below, click appropriate switching time.

One key switch

LVP615U's default signal switching mode is that clicking corresponding button in signal source selection area to switch signal.

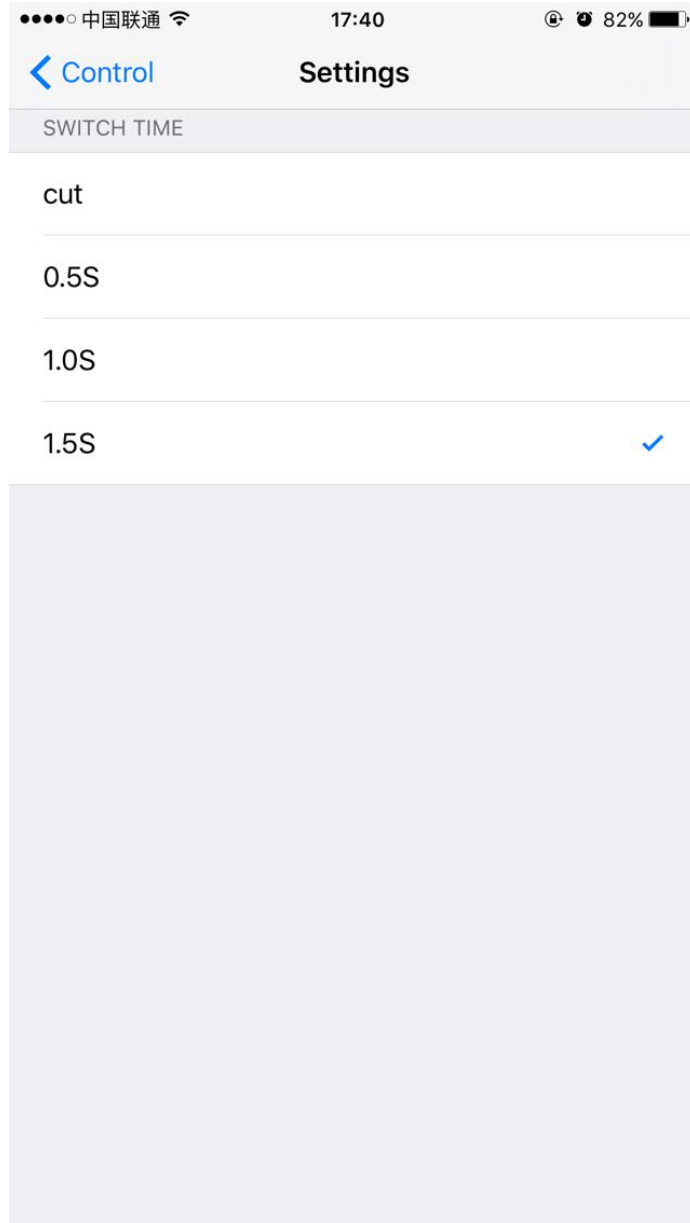

Preselect+Take Switch

The switch method's interface as below, preselect firstly through signal source button, then through **TAKE** button to switch input signal source; blue button indicates current signal, green button indicates preselected signal source.

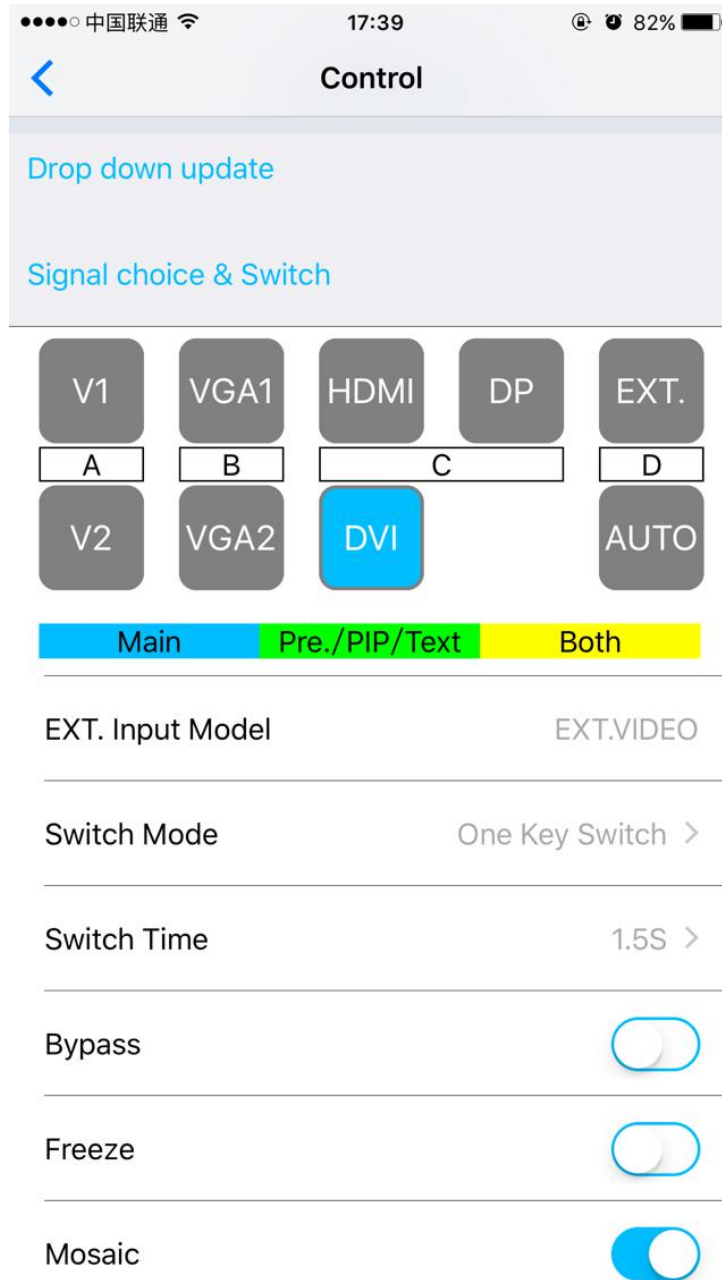

(2) PIP Display

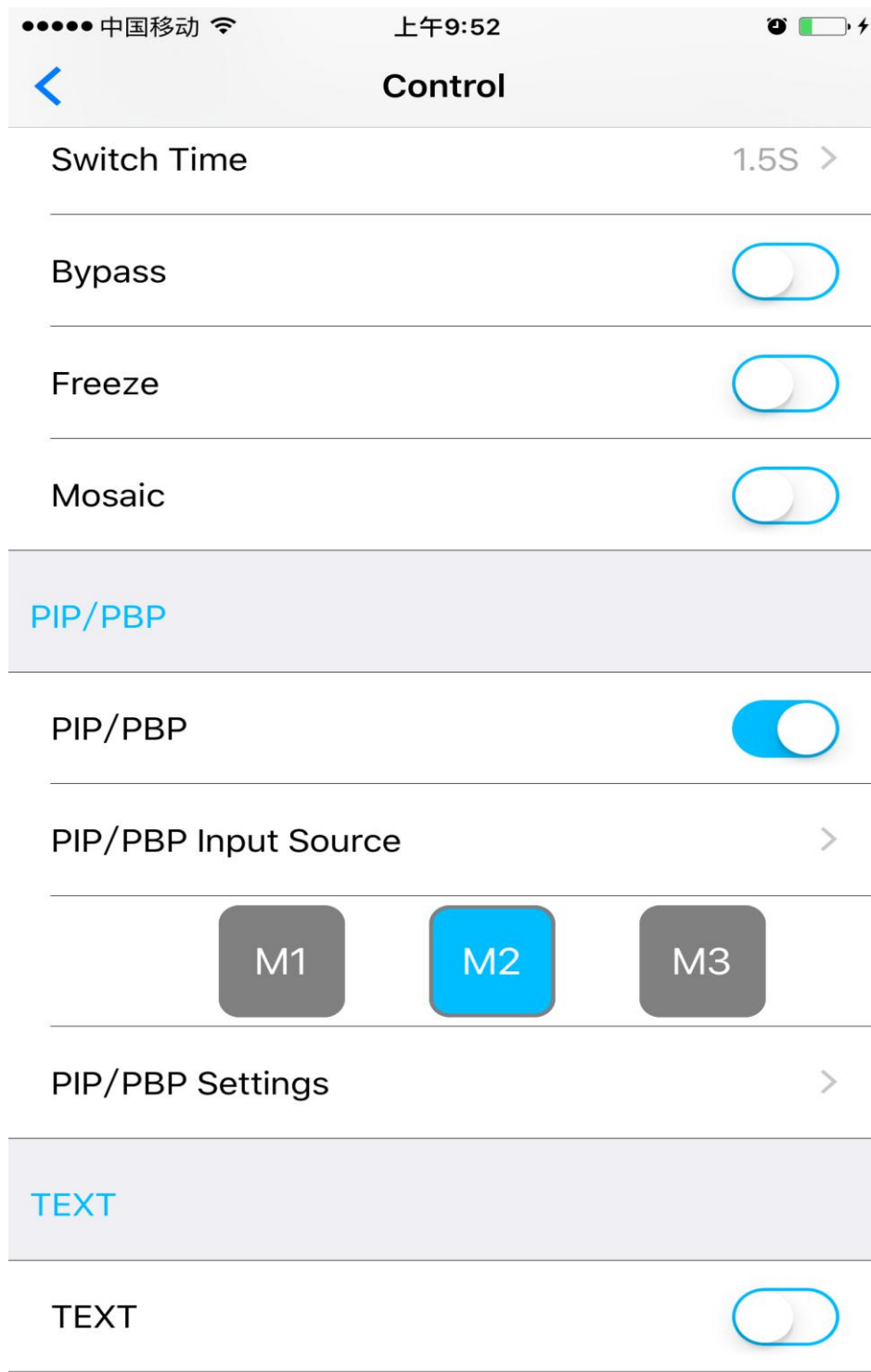

PIP operation interface as the picture above, operation steps:

Firstly in operation interface click PIP to open PIP function, then click PIP

signal in popping PIP signal selection interface; through mode button (M1,M2,M3) , Users could select corresponding display mode. Click **PIP setting** in popping setting interface, users can set the location and size of main signal and PIP signal.

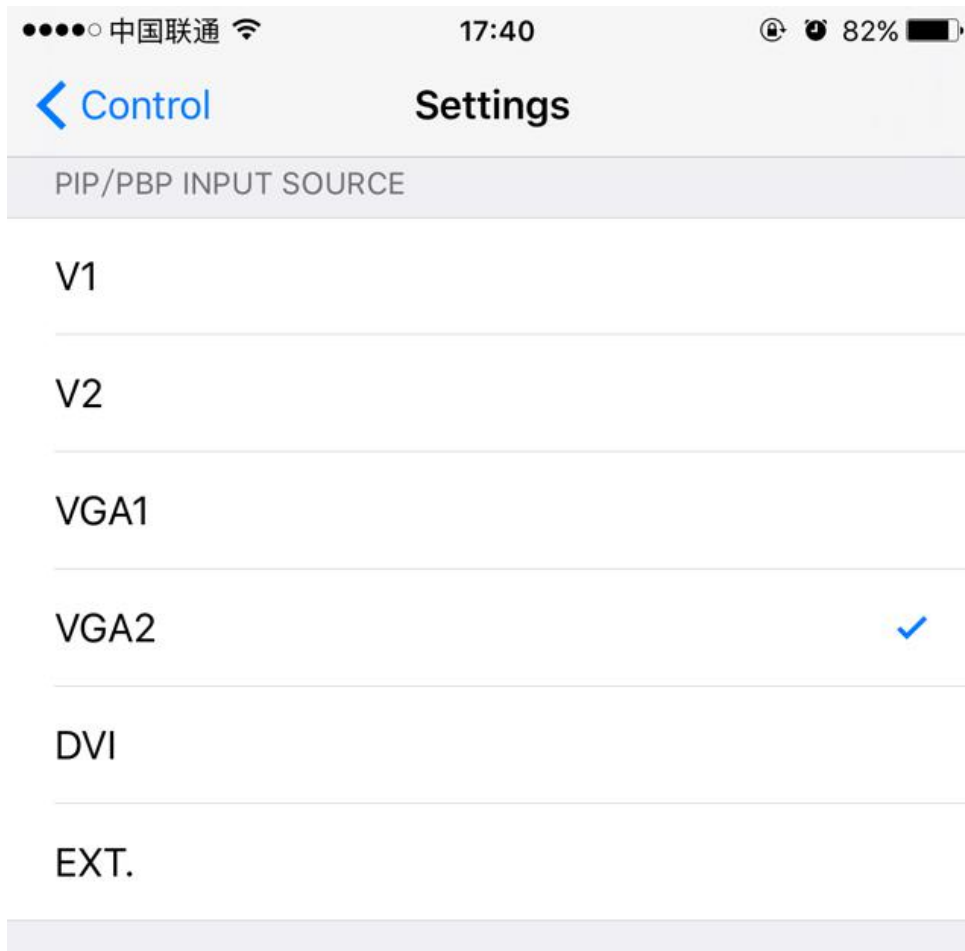

Interface of PIP Signal selection



User can input specific parameters of main window and PIP window. Press and to adjust.

Sketch map of main and PIP window's location size. By multi-point touching in the area, user could zoom in and zoom out the image; by single-point touching in the area, user could drag and adjust image location

(3) Text Overlay Display

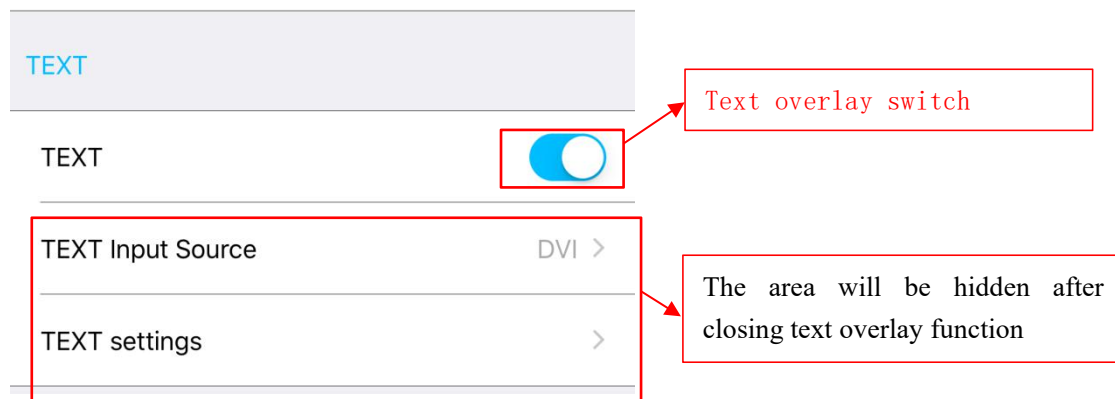

Text overlay switch

The area will be hidden after closing text overlay function

Text Overlay Operation Interface is as above, operation steps as followings:

Firstly in operation interface click **text overlay** to open the function, then click **text signal** select relative input signal in popping interface; if needly to set the text threshold and other parameters, users could click **text setting** in popping interface.



Text Signal Selection Interface

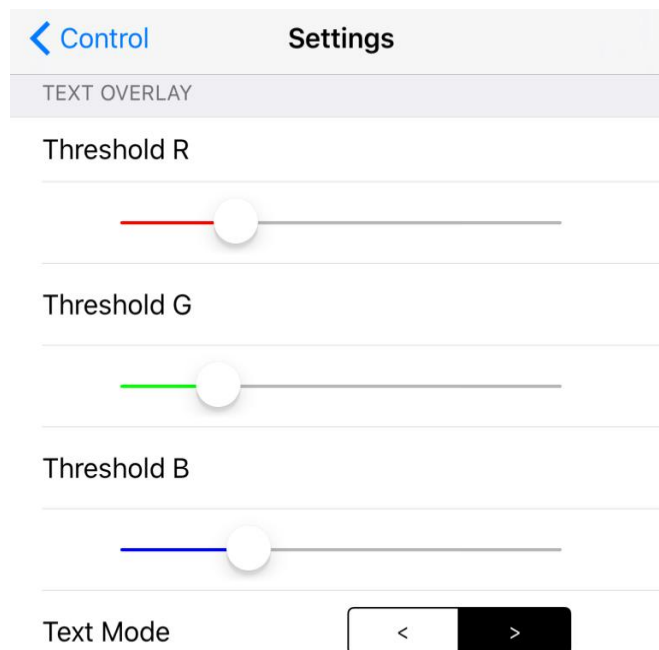

Text Parameter setting Interface

(4) Other Functions

Bypass



Freeze



Mosaic



Bypass: Corresponding with the button **BYPASS** on front panel, namely part or full display function button.

Freeze: Corresponding with the button **Freeze** on front panel; namely image freeze function button.

Mosaic: Corresponding with the button **Mosaic** on front panel, namely splicing function button.

AUTO: Corresponding with the button **AUTO** on front panel, namely VGA automatic adjustment button.

2) Adjustment Setting

Main setting functions on adjustment setting interface include: output resolution, output image parameter, input video signal, video quality, audio, communication and language. In setting interface, clicking corresponding setting item can enter corresponding setting interface.

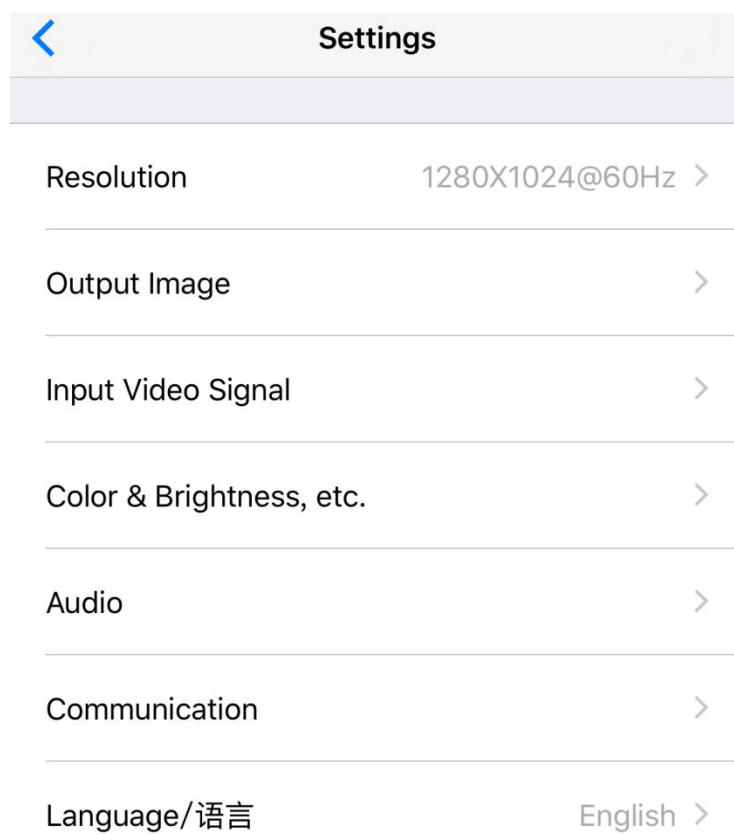

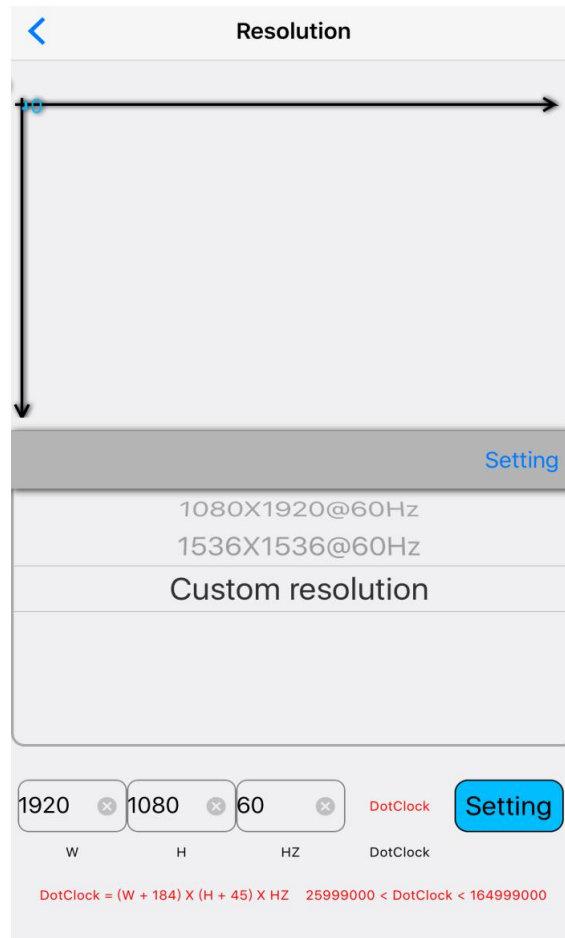

(1) Output Resolution

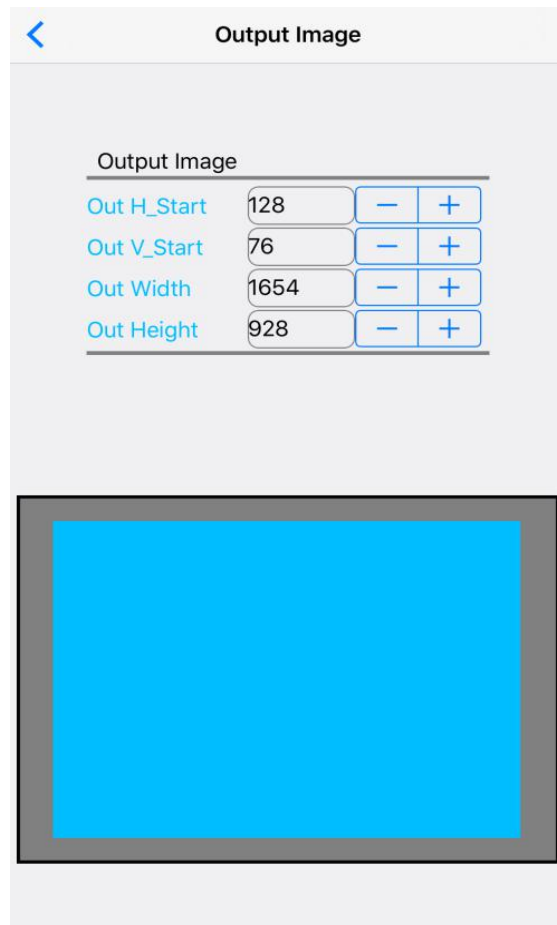

Select the appropriate resolution in output resolution menu. And click **setting**, the processor will change to new resolution. If selecting custom resolution, user needs to set the corresponding width, height and frame frequency.

(2) Output Image Parameter



The interface is used to set the location and size of output image, user could enter parameter manually, then through  and  to adjust parameters, in diagram area of output parameters, through multiple-point touching to zoom in or zoom out image size, single-point touching to drag and adjust image location.

(3) Input video signal

User can open input video hot spare and configure V2/YPbPr port.

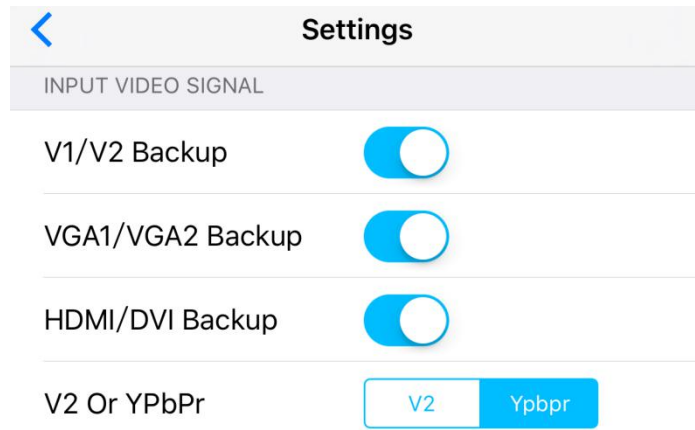

(4) Image quality

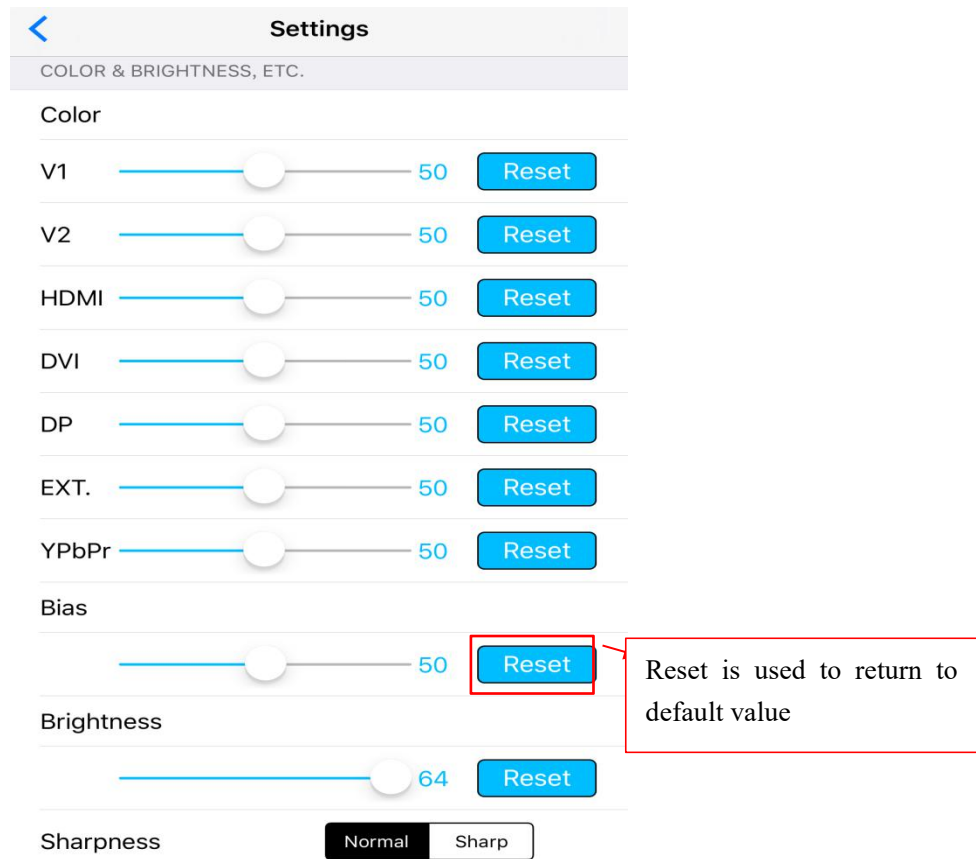

In image quality interface, users could set LVP615U output brightness, sharpness, bias and set every input signal's color independently.

(5) Audio



Audio setting interface could set LVP615U's corresponding input signals of two audio inputs, in order to achieve audio and video synchronous switch.

(6) Network Setting

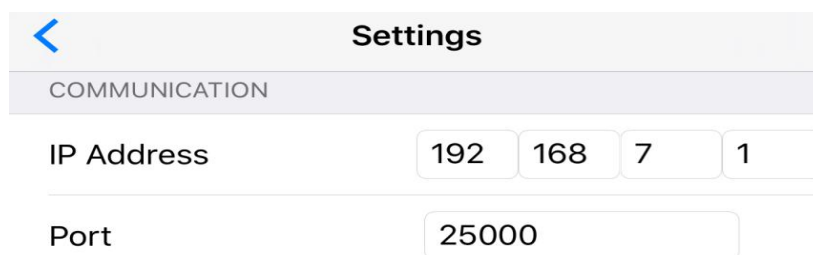

Network setting menu is used to input network parameter of LVP615U, this is the premise of remote control.

(7) Language Setting

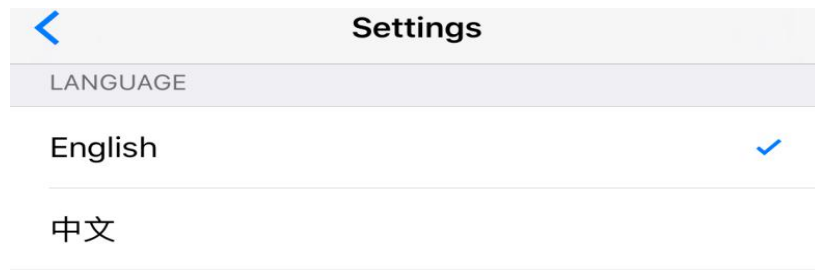

LVP615U remote control APP only support Chinese and English interface presently, click language and exit language setting interface, then the language selected will be applied.

3) Mosaic setting

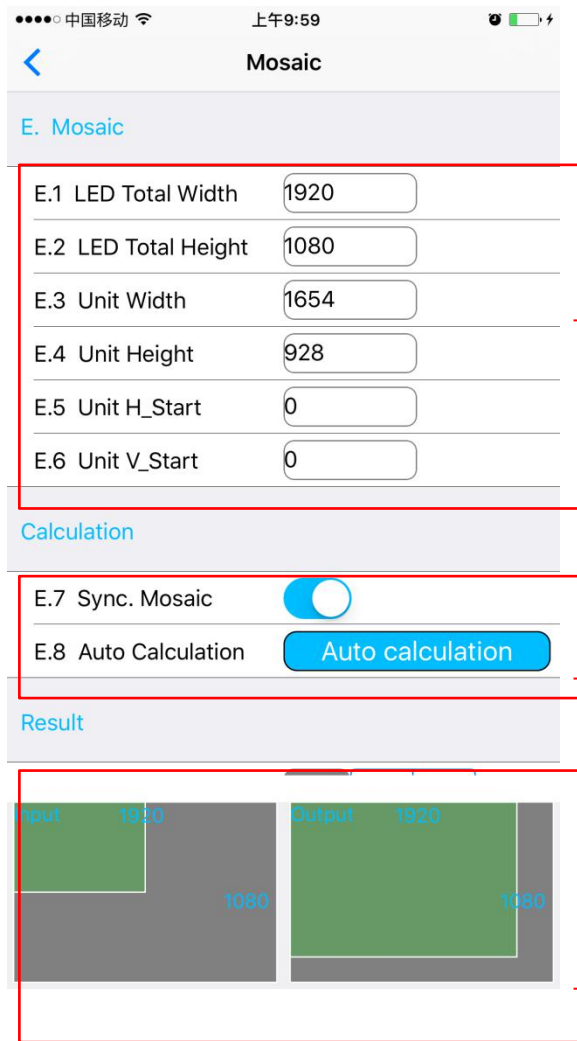

Step1. Enter the size of whole screen, and the size and location of the processor in use

Step2. Open synchronous Mosaic, click auto calculation, APP will calculate the splicing parameters and apply it automatically.

Step3. Confirm image Mosaic effect, and make some small adjustments on mosaic parameters.

Mosaic setting interface can achieve quick mosaic parameter setting

To achieve splicing function before entering Mosaic, need to make sure these settings as below.

- (1) The current input signal is DVI
- (2) The resolution of DVI input signal must be as same as the output resolution of processor
- (3) Mosaic function is open correctly

Operation step described as the picture above:

- (1) Input in relative parameters of actual screen
- (2) Open synchronization mosaic, click automatic mosaic, APP calculates the parameters automatically and apply it
- (3) Confirm image splicing effect, if some problem, adjust and amend the parameter APP calculated out.

4) Information display



The interface includes the APP-controllable model, APP version information and company information.

Chapter 8 copyright information

The copyright of this Manual is owned by SHENZHEN VDWALL CO.,LTD., unless with prior consent of VDWALL, nobody is permitted to copy or use any part or all of the information contained herein.

This Manual is provided for reference only, VDWALL reserves right to change the product appearance, dimensions and specifications from time to time without notice to users.

Appendix: modify the record table

version	time	description	draft
V1.0	2017.5.24	LVP615U first release	Lts

LVP615U 使用说明
